



Fittings Product Catalog



vnestainless.com



VNE Corporation

P.O. Box 1698 • 1149 Barberry Drive • Janesville, WI 53547
608-756-4930 • 1-800-356-1111 • Fax: 608-756-3643

VNE FITTINGS PRODUCT CATALOG



TABLE OF CONTENTS

CLAMP FITTINGS

PAGE 1-24

| | |
|---|-------|
| Clamp Specifications..... | 2 |
| Clamp Industry Cross - Reference..... | 3 |
| Clamp Elbows..... | 4-6 |
| Clamp Tees..... | 6 |
| Clamp Cross..... | 7 |
| Clamp Ferrules..... | 7-10 |
| Clamp Adapters..... | 10-13 |
| Clamp Caps..... | 13-14 |
| Clamp Gaskets..... | 14 |
| Clamps..... | 14-16 |
| Clamp PSI Ratings..... | 16-17 |
| Clamp Lateral & True Y..... | 17 |
| Clamp Reducing Lateral..... | 18 |
| Clamp Adapter Reducers..... | 18-22 |
| Clamp Schedule 5 & 10 Ferrules,Caps, Clamps,Gaskets, & PSI Ratings..... | 22-24 |

WELD FITTINGS

PAGE 25-40

| | |
|--|-------|
| Weld Specifications..... | 26 |
| Weld Industry Cross - Reference..... | 27 |
| Weld Elbows..... | 28-31 |
| Weld Tees..... | 31-36 |
| Weld Crosses, Stub Ends & Caps..... | 36 |
| Weld Lateral, True Y & Reducing Lateral..... | 37 |
| Weld Reducers..... | 38-40 |
| Weld Adapters..... | 40 |

BEVEL SEAT & JOHN PERRY FITTINGS

PAGE 41-56

| | |
|--|-------|
| Bevel Seat Specifications..... | 42 |
| Bevel Seat Industry Cross - Reference..... | 43 |
| Bevel Seat Elbows..... | 44-45 |
| Bevel Seat Tees..... | 45 |
| Bevel Seat Crosses & Hex Union Nuts..... | 46 |
| Bevel Seat Ferrules..... | 46-49 |
| Bevel Seat Caps..... | 49 |
| Bevel Seat Adapters..... | 50-51 |
| Bevel Seat Reducers..... | 52-54 |
| John Perry Ferrules, & Caps..... | 55-56 |

E-LINE FITTINGS

PAGE 57-76

| | |
|--|-------|
| E-Line Specifications..... | 58 |
| E-Line Industry Cross - Reference..... | 59 |
| E-Line Elbows..... | 60-61 |
| E-Line Tees..... | 61-62 |
| E-Line Crosses..... | 63 |
| E-Line Ferrules..... | 63-64 |
| E-Line Adapters..... | 64-65 |
| E-Line Weld Ferrules..... | 65 |
| E-Line Adapters..... | 65-68 |
| E-Line Caps, Laterals, True Y, Gaskets & Clamps..... | 69-70 |
| E-Line Clamp PSI Ratings..... | 71 |
| E-Line Reducers..... | 71-73 |

| | | |
|--|---|-------------------|
| | E-LINE FITTINGS (cont.) | PAGE 57-76 |
| | E-Line Schedule 5 (T316L), Short Welding Ferrules..... | 74 |
| | E-Line Schedule 5 (T316L), Caps..... | 74 |
| | E-Line Schedule 5 (T316L), Long Welding Ferrules..... | 75 |
| | E-Line Schedule 5 (T316L), Clamps..... | 75 |
| | E-Line EQ-Line..... | 76 |
| | UNPOLISHED TUBE OD FITTINGS | PAGE 77-84 |
| | Unpolished Tube OD Specifications..... | 78 |
| | Unpolished Tube OD Elbows..... | 79-80 |
| | Unpolished Tube OD Tees..... | 80-81 |
| | Unpolished Tube OD Crosses..... | 81 |
| | Unpolished Tube OD Type A Stud with Grooves..... | 81 |
| | Unpolished Tube OD Type B Stud End Less Grooves..... | 82 |
| | Unpolished Tube OD Caps..... | 82 |
| | Unpolished Tube OD Adapters..... | 82 |
| | Unpolished Tube OD Laterals & True Y..... | 83 |
| | Unpolished Tube OD Reducers..... | 83-84 |
| | Unpolished Tube OD Flange & Rubber Hose Barb Blank..... | 84 |
| | Miscellaneous | |
| | European Din Specifications..... | 86 |
| | European Din Nut & Gaskets..... | 87 |
| | European Din Ferrules & Caps..... | 88 |
| | European Din X Inch Weld Ferrules..... | 89 |
| | Pipe Hanger Specifications..... | 90 |
| | Pipe Hangers..... | 91 |
| | Speciality Products..... | 92 |
| | Additional Products..... | 93 |
| | Affiliations..... | 94 |

FITTINGS



Clamp Fittings



CLAMP FITTINGS....

Clamp Style Fittings are most popular for easy assembly and breakdown of process lines and equipment. VNE offers Clamp Fittings in T304 and T316L materials in 1/2" through 12" sizes.

Gaskets for Clamp Fittings are available in several different materials, Buna-N, EPDM, Silicone, Tef-Steel®, Teflon®, and Viton®. Lightweight and heavy-duty clamps complete the unions. VNE's Clamp Fittings meet all 3A requirements.

CLAMP FITTING SPECIFICATIONS....

Size Range: 1/2" OD through 12" OD

Materials: T304
T316L

Finish: No. 7 - ID & OD
No. 5 - OD only
No. 3 - ID only
No. 1 - unpolished

ORDERING SPECIFICATIONS....

- Specify:**
- Quantity
 - Product description or Part No.
 - Size
 - Material Type
 - Polish Requirements

LIMITED WARRANTY....

VNE Corporation products are warranted to be free from defects in material and workmanship for a period of one year from the date of shipment. Any product that proves to be defective shall be repaired or replaced at the option of VNE, providing it has been used as recommended and in strict accordance with recognized piping practices, and that has not been subject to extraordinary service, such as encountered under severe corrosive or abrasive conditions.

VNE makes no warranties, express or implied, other than those listed above.

VNE shall not be liable for any consequential, indirect, incidental or contingent damages.

VNE CORPORATION

P.O. Box 1698 • 1149 Barberry Drive • Janesville, WI 53547

TEL: 608-756-4930 • FAX: 608-756-3643 • 1-800-356-1111 • Web site: vnestainless.com

CLAMP TYPE

| VNE | TRI-CLOVER | WAUKESHA | G & H | JENSEN |
|----------|------------|-----------|---------|---------|
| EG2C | 2CMP | 2CMP | GC2C | JC2 |
| EGLC31CC | 2CMP-31MP | 2CMP-31MP | GC2C-31 | JC2-J31 |
| EG2FPR | 2FMP-14 | 2FMP-14 | GC2F-14 | JC2-14 |
| EG2WU | ----- | ----- | GC2WU | J2WU |
| EG2FTR | 2FMP-15 | 2FMP-15 | GC2F-15 | JC2-15 |
| EG2K | 2KMP | 2KMP | GC2K | JC2K |
| EG7 | 7MP | 7MP | GC7 | JC7 |
| EG7R | 7RMP | 7RMP | GC7R | JC7R |
| EG9 | 9MP | 9MP | GC9 | JC9 |
| EG13 | 13MHLA | ----- | GH13FAH | K13LH |
| 13MHHM | 13MHHM | 13MHHM | GC13LAH | JC13HC |
| 13MHP | 13MHP | 13MHP | 13MHP | JC13HP |
| EG14HT | 14MPHT | 14MPHT | GC14AHT | JC14AHT |
| EG14W | 14MPW | 14MPW | GC14W | JC14H |
| EG14WL | 14WLMP | 14WLMP | GC14WL | JC14 |
| EG14AM7 | L14AM7 | L14AM7 | GC14AC | JC14AM7 |
| EG2CS | 14WMP | 14WMP | GC2CS | JC14X |
| EG14RT | 14MPHR | 14MPHR | GC14AHR | JC14AHR |
| EG16A | 16AMP | 16AMP | GC16A | JC16 |
| EG17PR | 17MP-14 | 17MP-14 | GC17PC | JC17-14 |
| EG17TR | 17MP-15 | 17MP-15 | GC17TC | JC17-15 |
| EG21 | 21MP | 21MP | GC21 | JC21 |
| EG22 | 22MP | 22MP | GC22 | JC22 |
| EG31R | 31RMP | 31RMP | GC31R | JC31R |
| EG31CC | 31-14MP | 31-14MP | GC31CC | JC31 |
| EG32CC | 32-14MP | 32-14MP | GC32CC | JC32 |
| EG31PC | 31PMP | 31PMP | GC31PC | J14-C31 |
| EG32PC | 32PMP | 32PMP | GC32PC | J14-C32 |
| EG31CP | 31MPP | 31MPP | GC31CP | JC31-14 |
| EG32CP | 32MPP | 32MPP | GC32CP | JC32-14 |
| EG31TC | 31TMP | 31TMP | GC31TC | J15-C31 |
| EG32TC | 32TMP | 32TMP | GC32TC | J15-C32 |
| EG31CT | 31MPT | 31MPT | GC31CT | JC31-15 |
| EG32CT | 32MPT | 32MPT | GC32CT | JC32-15 |
| EG40 | 40MPU | 40MPU | GC40 | JC40N |
| EG40T | 40MPG | 40MPG | GC40T | JC40T |
| EG45BY | 45BYMP | 45BYMP | GC45SH | ----- |
| 45C | B45MP | 45HMP | ----- | 45HC |
| EG23B | 23BMP | 23BMP | GC23B | JC23B |
| EG28A | 28AMP | 28AMP | GC28A | JC28A |
| EG28B | 28BMP | 28BMP | GC28B | JC28B |

EG2C - 90° ELBOW

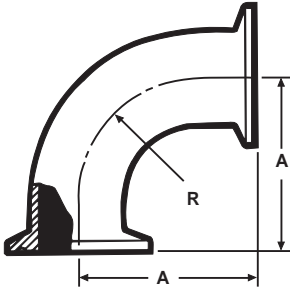

| Size Tube OD | A | R |
|-----------------|--------|--------|
| 1 | 2.000 | 1.500 |
| 1 1/2 | 2.750 | 2.250 |
| 2 | 3.500 | 3.000 |
| 2 1/2 | 4.250 | 3.750 |
| 3 | 5.000 | 4.500 |
| 4 | 6.625 | 6.000 |
| 6 | 9.875 | 9.000 |
| 8 | 12.937 | 12.000 |

EG2WU - CLAMP 180° U-BEND

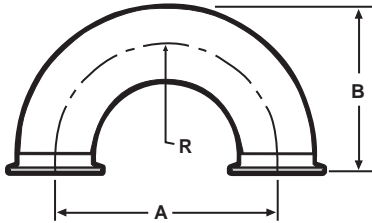

| Size Tube OD | A | B | R |
|-----------------|--------|--------|-------|
| 1/2 | 1.500 | 1.500 | 0.750 |
| 3/4 | 2.250 | 2.000 | 1.125 |
| 1 | 3.000 | 2.500 | 1.500 |
| 1 1/4 | 3.750 | 3.000 | 1.875 |
| 1 1/2 | 4.500 | 3.500 | 2.250 |
| 2 | 6.000 | 4.500 | 3.000 |
| 2 1/2 | 7.500 | 5.500 | 3.750 |
| 3 | 9.000 | 6.500 | 4.500 |
| 4 | 12.000 | 8.625 | 6.000 |
| 6 | 18.000 | 12.875 | 9.000 |

EG2FPR - 90° ELBOW

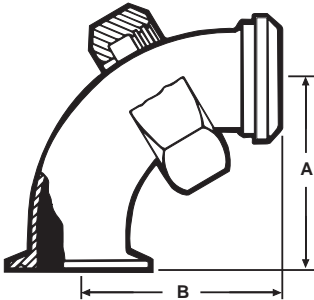

| Size Tube OD | A | B |
|-----------------|-------|-------|
| 1 | 2.000 | 2.875 |
| 1 1/2 | 2.750 | 2.968 |
| 2 | 3.500 | 3.718 |
| 2 1/2 | 4.250 | 4.593 |
| 3 | 5.000 | 5.406 |
| 4 | 6.625 | 7.218 |

EG2FTR - 90° ELBOW

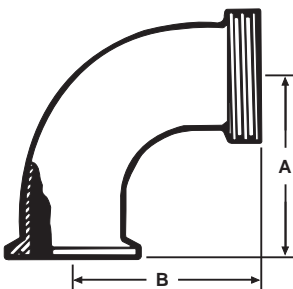

| Size Tube OD | A | B |
|-----------------|-------|-------|
| 1 | 2.000 | 2.187 |
| 1 1/2 | 2.750 | 2.968 |
| 2 | 3.500 | 3.718 |
| 2 1/2 | 4.250 | 4.593 |
| 3 | 5.000 | 5.406 |
| 4 | 6.625 | 7.218 |

**Note: One inch fittings take 1 1/2" clamps.
Fractional fittings take 3/4" clamps.**

EG2C31CC - 90° REDUCING ELBOW (Non-Tapered)

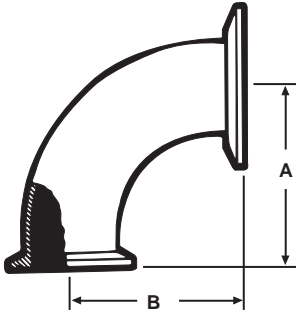

| Size Tube OD | A | B |
|-----------------|-------|-------|
| 2 x 1 | 2.000 | 2.000 |
| 2 x 1 1/2 | 2.750 | 2.750 |
| 2 1/2 x 1 1/2 | 2.750 | 2.750 |
| 2 1/2 x 2 | 3.500 | 3.500 |
| 3 x 1 1/2 | 2.750 | 2.750 |
| 3 x 2 | 3.500 | 3.500 |
| 3 x 2 1/2 | 4.250 | 4.250 |
| 4 x 2 1/2 | 4.250 | 4.375 |
| 4 x 3 | 5.000 | 5.125 |
| 6 x 4 | 6.625 | 6.875 |

EG231-FPR 90° REDUCING ELBOW (Non-Tapered)

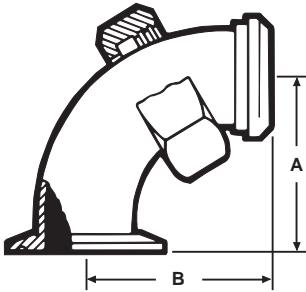

| Size Tube OD | A | B |
|-----------------|-------|-------|
| 2 x 1 | 2.000 | 2.187 |
| 2 x 1 1/2 | 2.750 | 2.968 |
| 2 1/2 x 1 1/2 | 2.750 | 2.968 |
| 2 1/2 x 2 | 3.500 | 3.718 |
| 3 x 1 1/2 | 2.750 | 2.968 |
| 3 x 2 | 3.500 | 3.718 |
| 3 x 2 1/2 | 4.250 | 4.593 |
| 4 x 2 1/2 | 4.375 | 4.593 |
| 4 x 3 | 5.125 | 5.406 |

EG2C31PR - 90° REDUCING ELBOW (Non-Tapered)

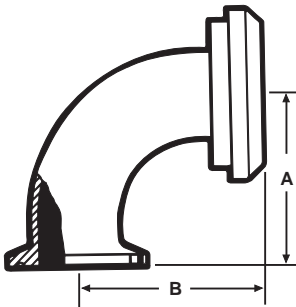

| Size Tube OD | A | B |
|-----------------|-------|-------|
| 2 x 1 | 2.000 | 2.250 |
| 2 x 1 1/2 | 2.750 | 3.000 |
| 2 1/2 x 1 1/2 | 2.750 | 3.031 |
| 2 1/2 x 2 | 3.500 | 3.781 |
| 3 x 1 1/2 | 2.750 | 3.593 |
| 3 x 2 | 3.500 | 3.843 |
| 3 x 2 1/2 | 4.250 | 4.593 |
| 4 x 2 1/2 | 4.250 | 4.687 |
| 4 x 3 | 5.000 | 5.437 |

Note: One inch fittings take 1 1/2" clamps.
Fractional fittings take 3/4" clamps.

EG2K - 45° ELBOW

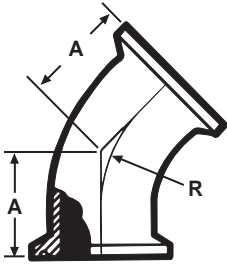

| Size Tube OD | A | R |
|-----------------|-------|--------|
| 1 | 1.125 | 1.500 |
| 1 1/2 | 1.437 | 2.250 |
| 2 | 1.750 | 3.000 |
| 2 1/2 | 2.062 | 3.750 |
| 3 | 2.375 | 4.500 |
| 4 | 3.125 | 6.000 |
| 6 | 4.625 | 9.000 |
| 8 | 5.312 | 12.000 |

EG7 - TEE

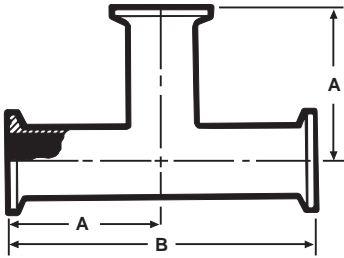

| Size Tube OD | A | B |
|-----------------|-------|--------|
| 1 | 2.375 | 4.750 |
| 1 1/2 | 2.750 | 5.500 |
| 2 | 3.500 | 7.000 |
| 2 1/2 | 3.500 | 7.000 |
| 3 | 3.750 | 7.500 |
| 4 | 4.500 | 9.000 |
| 6 | 8.875 | 17.750 |
| 8 | 9.937 | 19.875 |

EG7R - REDUCING TEE

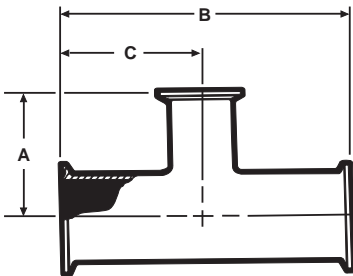

| Size Tube OD | A | B | C |
|-----------------|-------|--------|-------|
| 1 1/2 x 1 | 1.875 | 4.312 | 2.156 |
| 2 x 1 | 2.125 | 5.125 | 2.562 |
| 2 x 1 1/2 | 2.406 | 5.125 | 2.562 |
| 2 1/2 x 1 1/2 | 2.656 | 5.687 | 2.843 |
| 2 1/2 x 2 | 2.812 | 5.687 | 2.843 |
| 3 x 1 1/2 | 2.906 | 6.187 | 3.093 |
| 3 x 2 | 3.062 | 6.187 | 3.093 |
| 3 x 2 1/2 | 3.093 | 6.187 | 3.093 |
| 4 x 2 | 3.593 | 8.125 | 4.062 |
| 4 x 2 1/2 | 3.593 | 8.125 | 4.062 |
| 4 x 3 | 3.593 | 8.125 | 4.062 |
| 6 x 3 | 6.125 | 13.000 | 6.500 |
| 6 x 4 | 6.250 | 13.000 | 6.500 |

**Note: One inch fittings take 1 1/2" clamps.
Fractional fittings take 3/4" clamps.**

EG9 - CROSS

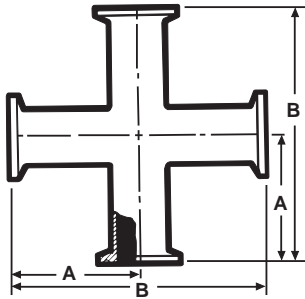

| Size Tube OD | A | B |
|-----------------|-------|--------|
| 1 | 2.375 | 4.750 |
| 1 1/2 | 2.750 | 5.500 |
| 2 | 3.500 | 7.000 |
| 2 1/2 | 3.500 | 7.000 |
| 3 | 3.750 | 7.500 |
| 4 | 4.500 | 9.000 |
| 6 | 8.875 | 17.340 |

EG14AM7 - WELDING FERRULE

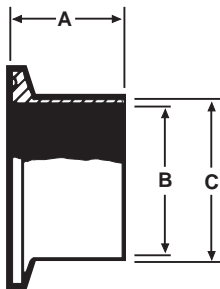

| Size Tube OD | A | B | C |
|-----------------|-------|--------|--------|
| 1/2 | 2.000 | 0.370 | 0.500 |
| 3/4 | 2.000 | 0.620 | 0.750 |
| 1 | 1.125 | 0.870 | 1.000 |
| 1 1/2 | 1.125 | 1.370 | 1.500 |
| 1 1/4 | 1.125 | 1.120 | 1.250 |
| 2 | 1.125 | 1.870 | 2.000 |
| 2 1/2 | 1.125 | 2.370 | 2.500 |
| 3 | 1.125 | 2.870 | 3.000 |
| 4 | 1.125 | 3.834 | 4.000 |
| 5 | 1.500 | 4.782 | 5.000 |
| 6 | 1.500 | 5.780 | 6.000 |
| 8 | 1.500 | 7.782 | 8.000 |
| 10 | 1.500 | 9.732 | 10.000 |
| 12 | 1.500 | 11.732 | 12.000 |

EG14R - RECESSLESS FERRULE (Expanding)

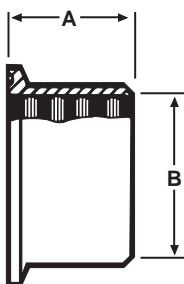

| Size Tube OD | A | B |
|-----------------|-------|-------|
| 1 | 0.687 | 1.000 |
| 1 1/2 | 1.125 | 1.500 |
| 2 | 1.312 | 2.000 |
| 2 1/2 | 1.375 | 2.500 |
| 3 | 1.437 | 3.000 |
| 4 | 1.500 | 4.000 |

Note: One inch fittings take 1 1/2" clamps.
Fractional fittings take 3/4" clamps.

EG2CS - SHORT WELDING FERRULE

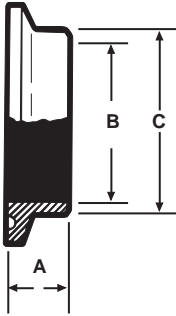

| Size Tube OD | A | B |
|-----------------|-------|--------|
| 1/4 | 0.500 | 0.120 |
| 3/8 | 0.500 | 0.245 |
| 1/2 | 0.500 | 0.370 |
| 5/8 | 0.500 | 0.495 |
| 3/4 | 0.500 | 0.620 |
| 1 | 0.500 | 0.870 |
| 1 1/4 | 0.500 | 1.120 |
| 1 1/2 | 0.500 | 1.370 |
| 2 | 0.500 | 1.870 |
| 2 1/2 | 0.500 | 2.370 |
| 3 | 0.500 | 2.870 |
| 4 | 0.625 | 3.834 |
| 5 | 0.750 | 4.780 |
| 6 | 0.875 | 5.780 |
| 8 | 0.937 | 7.782 |
| 10 | 0.937 | 9.732 |
| 12 | 0.937 | 11.732 |

EG2CS31D / EG2CS31 - SHORT REDUCING CLAMP FERRULES

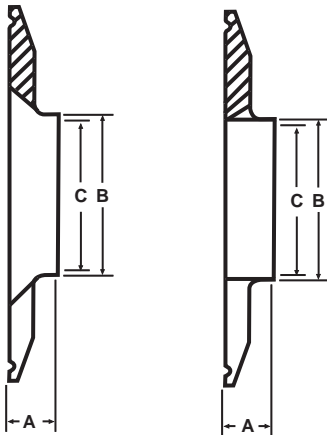

| Size Tube OD | A | B | C |
|-----------------|-------|-------|-------|
| 1 x 1/2 | 0.500 | 0.500 | 0.370 |
| 1 x 3/4 | 0.500 | 0.750 | 0.620 |
| 1 1/2 x 1 | 0.500 | 1.000 | 0.870 |
| 2 x 1 | 0.500 | 1.000 | 0.870 |
| 2 x 1 1/2 | 0.500 | 1.500 | 1.370 |
| 2 1/2 x 1 1/2 | 0.500 | 1.500 | 1.370 |
| 2 1/2 x 2 | 0.500 | 2.000 | 1.870 |
| 3 x 1 | 0.500 | 1.000 | 0.870 |
| 3 x 1 1/2 | 0.500 | 1.500 | 1.370 |
| 3 x 2 | 0.500 | 2.000 | 1.870 |
| 3 x 2 1/2 | 0.500 | 2.500 | 2.370 |
| 4 x 1 1/2 | 0.625 | 1.500 | 1.370 |
| 4 x 2 | 0.625 | 2.000 | 1.870 |
| 4 x 2 1/2 | 0.625 | 2.500 | 2.370 |
| 4 x 3 | 0.625 | 3.000 | 2.870 |
| 6 x 4 | 0.870 | 4.000 | 3.834 |

**Note: One inch fittings take 1 1/2" clamps.
Fractional fittings take 3/4" clamps.**

EG14W - TANK WELDING FERRULE

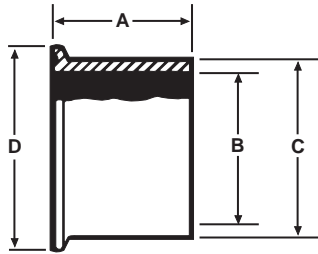

| Size Tube OD | A | B | C | D |
|-----------------|-------|-------|-------|-------|
| 1 | 1.625 | 0.870 | 1.160 | 1.984 |
| 1 1/2 | 1.625 | 1.370 | 1.676 | 1.984 |
| 2 | 1.750 | 1.870 | 2.192 | 2.516 |
| 2 1/2 | 1.750 | 2.370 | 2.708 | 3.047 |
| 3 | 1.812 | 2.870 | 3.224 | 3.579 |
| 4 | 2.125 | 3.834 | 4.256 | 4.682 |
| 6 | 4.250 | 5.782 | 6.500 | 6.570 |

EG14W-C6L - ASME CODED TANK FERRULE

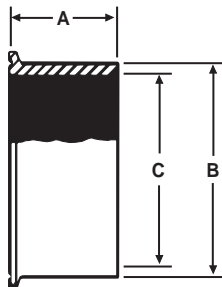

| Size Tube OD | A | B | C |
|-----------------|-------|-------|-------|
| 1 | 1.625 | 1.160 | 0.870 |
| 1 1/2 | 1.625 | 1.676 | 1.370 |
| 2 | 1.750 | 2.192 | 1.870 |
| 2 1/2 | 1.750 | 2.708 | 2.370 |
| 3 | 1.812 | 3.224 | 2.870 |
| 4 | 2.125 | 4.256 | 3.834 |
| 6 | 4.250 | 6.500 | 5.782 |

EG14WSL-C6L - ASME CODED TANK FERRULE LONG

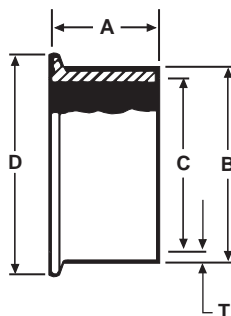

| Size Tube OD | A | B | C | D | Nom. Wall (T) |
|-----------------|-------|-------|-------|-------|------------------|
| 1 | 2.500 | 1.160 | 0.870 | 1.984 | 0.129 |
| 1 1/2 | 2.500 | 1.676 | 1.370 | 1.984 | 0.153 |
| 2 | 2.500 | 2.192 | 1.870 | 2.516 | 0.161 |
| 2 1/2 | 3.500 | 2.708 | 2.370 | 3.047 | 0.169 |
| 3 | 4.500 | 3.224 | 2.870 | 3.579 | 0.177 |
| 4 | 4.500 | 4.256 | 3.834 | 4.682 | 0.211 |
| 6 | 6.250 | 6.500 | 5.782 | 6.570 | 0.359 |

Note: One inch fittings take 1 1/2" clamps.
Fractional fittings take 3/4" clamps.

EG14WL - TANK WELDING FERRULE

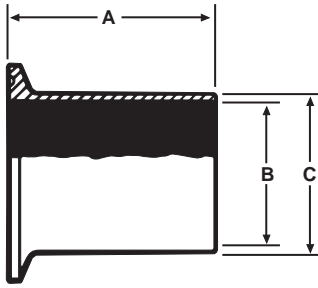

| Size Tube OD | A | B | C |
|-----------------|-------|--------|--------|
| 1 | 3.000 | 0.870 | 1.000 |
| 1 1/2 | 3.000 | 1.370 | 1.500 |
| 2 | 3.000 | 1.870 | 2.000 |
| 2 1/2 | 3.000 | 2.370 | 2.500 |
| 3 | 4.000 | 2.870 | 3.000 |
| 4 | 4.000 | 3.834 | 4.000 |
| 6 | 6.000 | 5.782 | 6.000 |
| 8 | 6.000 | 7.782 | 8.000 |
| 10 | 6.000 | 9.730 | 10.000 |
| 12 | 6.000 | 11.730 | 12.000 |

EG14RT - RUBBER HOSE ADAPTER



| Size Tube OD | |
|-----------------|----------------------------|
| 1/2 | CONTACT VNE FOR DIMENSIONS |
| 3/4 | |
| 1 | |
| 1 1/4 | |
| 1 1/2 | |
| 2 | |
| 2 1/2 | |
| 3 | |
| 4 | |
| 6 | |

EG14RT - RUBBER HOSE ADAPTER REDUCER (T316L)

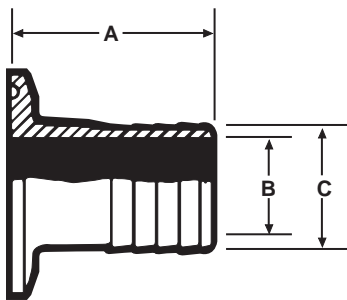

| Size Tube OD | A | B | C |
|-----------------|-------|-------|-------|
| 1 x 1/2 | 2.000 | 0.370 | 0.500 |
| 1 x 3/4 | 2.000 | 0.620 | 0.750 |
| 1 1/2 x 1 1/4 | 3.500 | 1.120 | 1.250 |
| 2 x 1 | 3.500 | 0.870 | 1.000 |
| 2 x 1 1/2 | 3.500 | 1.370 | 1.500 |
| 2 1/2 x 2 | 3.500 | 1.870 | 2.000 |
| 3 x 2 | 3.500 | 1.870 | 2.000 |
| 3 x 2 1/2 | 3.500 | 2.370 | 2.500 |
| 4 x 2 1/2 | 3.625 | 2.370 | 2.500 |
| 4 x 3 | 3.625 | 3.870 | 3.000 |

**Note: One inch fittings take 1 1/2" clamps.
Fractional fittings take 3/4" clamps.**

EG14HT - TYGON HOSE ADAPTER

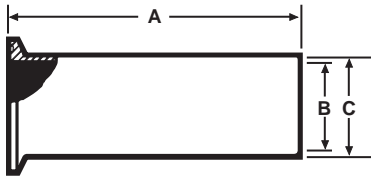

| Size Tube OD | A | B | C |
|-----------------|-------|-------|-------|
| 1 | 4.500 | 0.870 | 1.000 |
| 1 1/2 | 4.500 | 1.370 | 1.500 |
| 2 | 4.500 | 1.870 | 2.000 |
| 2 1/2 | 4.500 | 2.370 | 2.500 |
| 3 | 4.500 | 2.870 | 3.000 |
| 4 | 4.625 | 3.834 | 4.000 |

EG17PR - ADAPTER

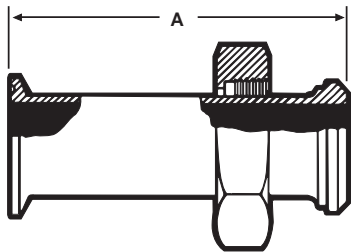

| Size Tube OD | A |
|-----------------|-------|
| 1 | 2.500 |
| 1 1/2 | 2.625 |
| 2 | 2.625 |
| 2 1/2 | 2.875 |
| 3 | 2.875 |
| 4 | 2.875 |

EG17TR - ADAPTER



| Size Tube OD | A |
|-----------------|-------|
| 1 | 1.187 |
| 1 1/2 | 1.187 |
| 2 | 1.218 |
| 2 1/2 | 1.343 |
| 3 | 1.437 |
| 4 | 2.125 |

EG21 - MALE ADAPTER (N.P.T. Pipe Threads)

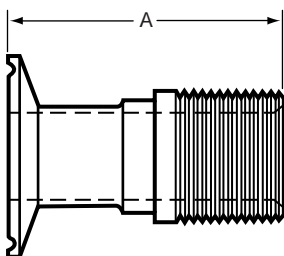

| Size Tube OD | A |
|-----------------|-------|
| 1 | 2.875 |
| 1 1/4 | 2.875 |
| 1 1/2 | 2.875 |
| 2 | 2.937 |
| 2 1/2 | 3.437 |
| 3 | 3.625 |
| 4 | 3.812 |
| 6 | 4.875 |

Note: One inch fittings take 1 1/2" clamps.
Fractional fittings take 3/4" clamps.

EG21-6L - MALE ADAPTER REDUCING (T316L)

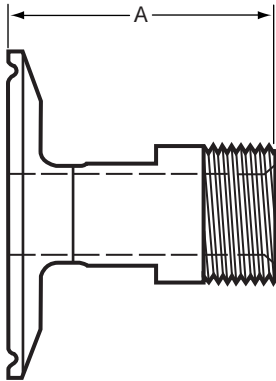

| Size Tube OD | A |
|-----------------|-------|
| 3/4 x 1/2 | 2.125 |
| 1 x 1/2 | 2.125 |
| 1 x 3/4 | 2.125 |
| 1 1/2 x 1/2 | 2.125 |
| 1 1/2 x 3/4 | 2.125 |
| 1 1/2 x 1 1/4 | 2.250 |
| 2 x 1 | 2.250 |
| 2 x 1 1/4 | 2.250 |
| 2 x 1 1/2 | 2.250 |
| 2 1/2 x 1 1/2 | 2.250 |
| 2 1/2 x 2 | 2.312 |
| 3 x 1 1/2 | 2.250 |
| 3 x 2 | 2.312 |
| 3 x 2 1/2 | 2.812 |
| 4 x 2 | 2.312 |
| 4 x 2 1/2 | 2.812 |
| 4 x 3 | 3.000 |
| 6 x 4 | 3.062 |

Sanitary end dimension listed first.

EG22 - FEMALE ADAPTER (N.P.T. Pipe Threads)

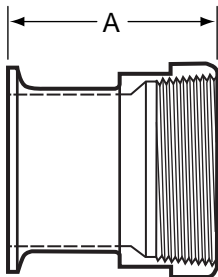

| Size Tube OD | A |
|-----------------|-------|
| 1 | 2.250 |
| 1 1/4 | 2.500 |
| 1 1/2 | 2.562 |
| 2 | 2.562 |
| 2 1/2 | 2.750 |
| 3 | 2.937 |
| 4 | 3.750 |

**Note: One inch fittings take 1 1/2" clamps.
Fractional fittings take 3/4" clamps.**

EG22 - FEMALE ADAPTER REDUCING (T316L)

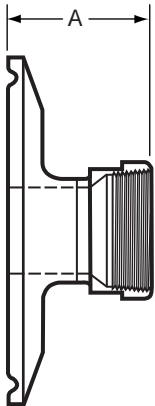

| Size Tube OD | A |
|-----------------|-------|
| 3/4 x 1/2 | 1.625 |
| 1 x 1/2 | 1.625 |
| 1 x 3/4 | 1.625 |
| 1 1/2 x 1/2 | 1.625 |
| 1 1/2 x 3/4 | 1.625 |
| 1 1/2 x 1 1/4 | 2.560 |
| 2 x 1 | 1.625 |
| 2 x 1 1/4 | 1.927 |
| 2 x 1 1/2 | 1.937 |
| 2 1/2 x 1 1/2 | 1.937 |
| 2 1/2 x 2 | 1.937 |
| 3 x 1 1/2 | 1.937 |
| 3 x 2 | 1.937 |
| 3 x 2 1/2 | 2.125 |
| 4 x 2 | 2.062 |
| 4 x 2 1/2 | 2.250 |
| 4 x 3 | 2.437 |

Sanitary end dimension listed first.

EG16A - SOLID END CAP



| Size Tube OD | A | B |
|-----------------|--------|-------|
| 1/2 & 3/4 | 0.992 | 0.200 |
| 1 & 1 1/2 | 1.984 | 0.250 |
| 2 | 2.516 | 0.250 |
| 2 1/2 | 3.047 | 0.250 |
| 3 | 3.579 | 0.250 |
| 4 | 4.682 | 0.312 |
| 5 | 5.692 | 0.385 |
| 6 | 6.570 | 0.437 |
| 8 | 8.570 | 0.437 |
| 10 | 10.570 | 0.562 |
| 12 | 12.570 | 0.625 |

1 1/2" caps are used on both 1" and 1 1/2" lines.

3/4" caps are used on both 1/2" & 3/4" lines.

**Note: One inch fittings take 1 1/2" clamps.
Fractional fittings take 3/4" clamps.**

EG23B-6L - CLAMP THERMOMETER CAPS (T316L)

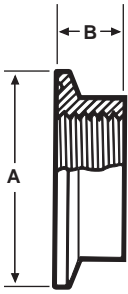

| Size Tube OD | A | B |
|-----------------|-------|-------|
| *1 | 1.984 | 0.625 |
| 1 1/2 | 1.984 | 0.625 |
| 2 | 2.516 | 0.625 |
| 2 1/2 | 3.047 | 0.625 |
| 3 | 3.579 | 0.625 |
| 4 | 4.682 | 0.625 |

*STD - 1/2 FNPT. All others 3/4" FNPT

Note: Other tap sizes are available.

GASKETS



| Gasket Materials | Part Number | Flange Type |
|------------------|-------------|-------------|
| Buna N | EG40 | EG40F |
| EPDM | EG40E | EG40FE |
| Teflon | EG40T | |
| Viton® | EG40V | EG40FV |
| Silicone | EG40S | EG40FS |
| TEF-Steel | EG40TS | |

Envelope Type

Teflon with EPDM Filler

EG40GR

Teflon with Viton Filler

EG40GRV

Available in 1/2" to 12" sizes.

13MHM - HEAVY DUTY CLAMP

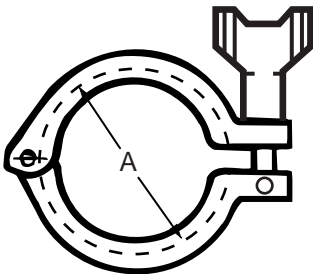

| Size Tube OD | A |
|-----------------|--------|
| 3/4 | 1.125 |
| 1 1/2 | 2.122 |
| 2 | 2.654 |
| 2 1/2 | 3.185 |
| 3 | 3.717 |
| 4 | 4.820 |
| 5 | 5.817 |
| 6 | 6.695 |
| 8 | 8.695 |
| 10 | 10.695 |
| 12 | 12.695 |

Note: One inch fittings take 1 1/2" clamps.
Fractional fittings take 3/4" clamps.

13MHHM-H - HEAVY DUTY CLAMP (Wing nut With Hole)

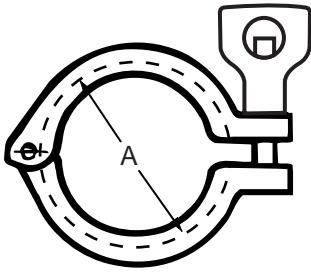

| Size Tube OD | A |
|-----------------|--------|
| 3/4 | 1.125 |
| 1 & 1/2 | 2.122 |
| 2 | 2.654 |
| 2 1/2 | 3.185 |
| 3 | 3.717 |
| 4 | 4.820 |
| 5 | 5.817 |
| 6 | 6.695 |
| 8 | 8.695 |
| 10 | 10.695 |
| 12 | 12.695 |

13MHHMD - DOUBLE HINGED HEAVY DUTY CLAMP

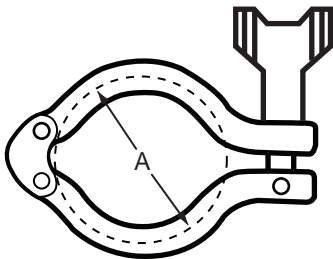

| Size Tube OD | A |
|-----------------|-------|
| 1 1/2 | 2.122 |
| 2 | 2.654 |
| 2 1/2 | 3.185 |
| 3 | 3.717 |
| 4 | 4.820 |

13MHHMD - H - DOUBLE HINGED HEAVY DUTY CLAMP

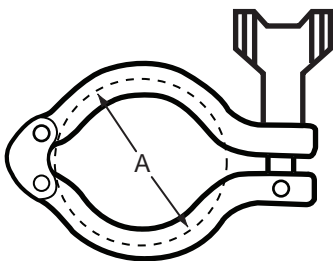

| Size Tube OD | A |
|-----------------|-------|
| 1 1/2 | 2.122 |
| 2 | 2.654 |
| 2 1/2 | 3.185 |
| 3 | 3.717 |
| 4 | 4.820 |

13MHHS - THREE PIECE HEAVY DUTY CLAMP

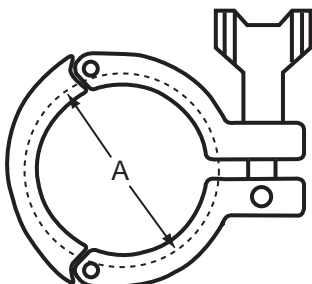

| Size Tube OD | A |
|-----------------|-------|
| 1 1/2 | 2.122 |
| 2 | 2.654 |
| 2 1/2 | 3.185 |
| 3 | 3.717 |
| 4 | 4.820 |

Note: One inch fittings take 1 1/2" clamps.
Fractional fittings take 3/4" clamps.

13MHP - HIGH PRESSURE CLAMP

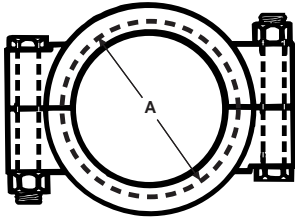

| Size Tube OD | A |
|-----------------|-------|
| 3/4 | 1.125 |
| 1 1/2 | 2.046 |
| 2 | 2.578 |
| 2 1/2 | 3.110 |
| 3 | 3.640 |
| 4 | 4.744 |
| 6 | 6.632 |

EG13 - HINGED CLAMP - (Light Duty)

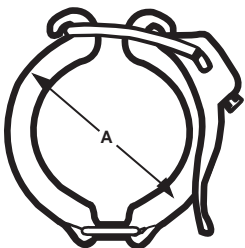

| Size Tube OD | A |
|-----------------|-------|
| 1 1/2 | 2.142 |
| 2 | 2.653 |
| 2 1/2 | 3.205 |
| 3 | 3.740 |
| 4 | 4.803 |

*PSI SERVICE RATINGS FOR SANITARY STAINLESS STEEL CLAMPS

| Size Tube OD | 13MHHM / 13MHHM - H | | 13MHHMD / 13MHHMD - H | |
|-----------------|---------------------|--------|-----------------------|--------|
| | @70°F | @250°F | @70°F | @250°F |
| 3/4" | 1500 | 1200 | | |
| 1 1/2" | 500 | 250 | 500 | 250 |
| 2" | 450 | 250 | 450 | 250 |
| 2 1/2" | 400 | 200 | 400 | 200 |
| 3" | 350 | 150 | 350 | 150 |
| 4" | 200 | 125 | 200 | 125 |
| 5" | 175 | 100 | | |
| 6" | 150 | 75 | | |
| 8" | 100 | 50 | | |
| 10" | 40 | 30 | | |
| 12" | 30 | 25 | | |

Note: One inch fittings take 1 1/2" clamps.
Fractional fittings take 3/4" clamps.

***PSI SERVICE RATINGS FOR SANITARY STAINLESS STEEL CLAMPS**

| Size Tube OD | 13MHHS | | 13MHP | | EG13 | |
|-----------------|--------|--------|-------|--------|-------|--------|
| | @70°F | @250°F | @70°F | @250°F | @70°F | @250°F |
| 3/4" | | | 1500 | 1200 | | |
| 1 1/2" | 600 | 300 | 1500 | 1200 | 150 | 125 |
| 2" | 550 | 275 | 1000 | 800 | 150 | 125 |
| 2 1/2" | 450 | 225 | 1000 | 800 | 150 | 125 |
| 3" | 350 | 160 | 1000 | 800 | 150 | 125 |
| 4" | 250 | 150 | 1000 | 800 | 150 | 125 |
| 5" | | | | | | |
| 6" | | | 300 | 200 | | |
| 8" | | | | | | |
| 10" | | | | | | |
| 12" | | | | | | |

*Service ratings are based upon hydrostatic tests using Standard Molded Buna-N gasket material with proper expansion of ferules, joint assembly, and the absence of shock pressure. All ratings systems are dependent upon related components in the system and proper installation.

EG28A - 45° CLAMP LATERAL

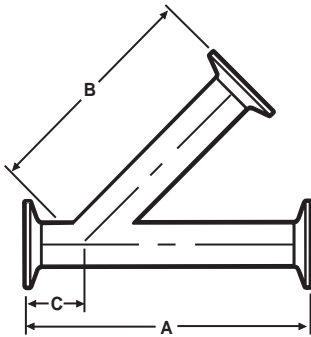

| Size Tube OD | A | B | C |
|-----------------|--------|--------|-------|
| 1 | 7.000 | 5.500 | 1.500 |
| 1 1/2 | 8.375 | 6.687 | 1.687 |
| 2 | 9.625 | 7.625 | 2.125 |
| 2 1/2 | 11.125 | 9.000 | 2.000 |
| 3 | 11.750 | 9.375 | 2.375 |
| 4 | 14.062 | 11.375 | 2.687 |
| 6 | 18.875 | 15.375 | 4.375 |

EG28B - CLAMP TRUE Y

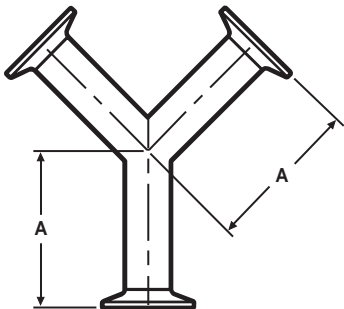

| Size Tube OD | A |
|-----------------|-------|
| 1 | 3.500 |
| 1 1/2 | 3.500 |
| 2 | 4.500 |
| 2 1/2 | 5.500 |
| 3 | 6.500 |
| 4 | 8.625 |
| 6 | 8.875 |

**Note: One inch fittings take 1 1/2" clamps.
Fractional fittings take 3/4" clamps.**

EG28RA - 45° CLAMP REDUCING LATERAL

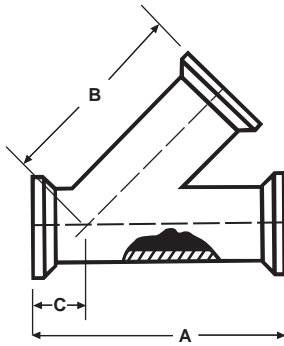

| Size Tube OD | A | B | C |
|-----------------|--------|--------|-------|
| 1 1/2 x 1 | 8.375 | 5.062 | 1.375 |
| 2 x 1 | 9.625 | 5.500 | 1.625 |
| 2 x 1 1/2 | 9.625 | 5.500 | 1.625 |
| 2 1/2 x 1 | 11.125 | 6.875 | 2.125 |
| 2 1/2 x 1 1/2 | 11.125 | 6.875 | 2.125 |
| 2 1/2 x 2 | 11.125 | 6.875 | 2.125 |
| 3 x 1 | 11.750 | 8.250 | 2.500 |
| 3 x 1 1/2 | 11.750 | 8.250 | 2.500 |
| 3 x 2 | 11.750 | 8.250 | 2.500 |
| 3 x 2 1/2 | 11.750 | 8.250 | 2.500 |
| 4 x 1 | 14.062 | 10.000 | 3.000 |
| 4 x 1 1/2 | 14.062 | 10.000 | 3.000 |
| 4 x 2 | 14.062 | 10.000 | 3.000 |
| 4 x 2 1/2 | 14.062 | 10.000 | 3.000 |
| 4 x 3 | 14.062 | 10.000 | 3.000 |

EG31CC - CONCENTRIC REDUCER

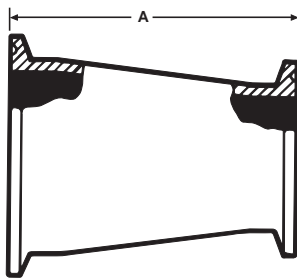

| Size Tube OD | A |
|-----------------|-------|
| 3/4 x 1/2 | 2.000 |
| 1 x 1/2 | 2.000 |
| 1 x 3/4 | 2.000 |
| 1 1/2 x 1/2 | 3.000 |
| 1 1/2 x 3/4 | 3.000 |
| 1 1/2 x 1 | 3.000 |
| 1 1/2 x 1 1/4 | 2.000 |
| 2 x 1 | 5.000 |
| 2 x 1 1/4 | 2.000 |
| 2 x 1 1/2 | 3.000 |
| 2 1/2 x 1 | 7.000 |
| 2 1/2 x 1 1/2 | 5.000 |
| 2 1/2 x 2 | 3.000 |
| 3 x 1 1/2 | 7.000 |
| 3 x 2 | 5.000 |
| 3 x 2 1/2 | 3.000 |
| 4 x 2 | 9.125 |
| 4 x 2 1/2 | 7.125 |
| 4 x 3 | 5.125 |
| 6 x 3 | 6.875 |
| 6 x 4 | 7.000 |

**Note: One inch fittings take 1 1/2" clamps.
Fractional fittings take 3/4" clamps.**

EG32CC - ECCENTRIC REDUCER

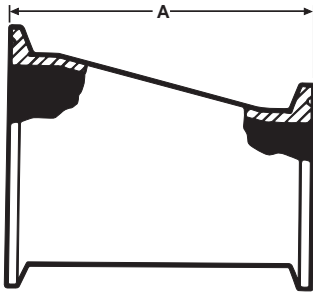

| Size Tube OD | A |
|-----------------|-------|
| 3/4 x 1/2 | 2.000 |
| 1 x 1/2 | 3.000 |
| 1 x 3/4 | 2.000 |
| 1 1/2 x 1/2 | 5.000 |
| 1 1/2 x 3/4 | 4.000 |
| 1 1/2 x 1 | 3.000 |
| 1 1/2 x 1 1/4 | 2.000 |
| 2 x 1 | 5.000 |
| 2 x 1 1/4 | 2.000 |
| 2 x 1 1/2 | 3.000 |
| 2 1/2 x 1 | 7.000 |
| 2 1/2 x 1 1/2 | 5.000 |
| 2 1/2 x 2 | 3.000 |
| 3 x 1 1/2 | 7.000 |
| 3 x 2 | 5.000 |
| 3 x 2 1/2 | 3.000 |
| 4 x 2 | 9.125 |
| 4 x 2 1/2 | 7.125 |
| 4 x 3 | 5.125 |
| 6 x 3 | 6.875 |
| 6 x 4 | 7.000 |

EG31PC - ADAPTER REDUCER (Concentric)

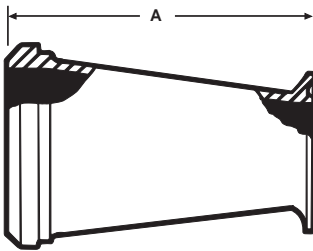

| Size Tube OD | A |
|-----------------|-------|
| *1 1/2 x 1 | 3.187 |
| 2 x 1 | 5.218 |
| 2 x 1 1/2 | 3.218 |
| 2 1/2 x 1 1/2 | 5.343 |
| 2 1/2 x 2 | 3.343 |
| 3 x 2 | 5.437 |
| 3 x 2 1/2 | 3.437 |
| 4 x 2 1/2 | 7.500 |
| 4 x 3 | 5.500 |

*Hex nut furnished

Note: One inch fittings take 1 1/2" clamps.
Fractional fittings take 3/4" clamps.

EG32PC - ADAPTER REDUCER (Eccentric)

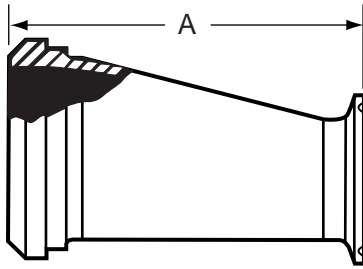

| Size Tube OD | A |
|-----------------|-------|
| *1 1/2 x 1 | 3.187 |
| 2 x 1 | 5.218 |
| 2 x 1 1/2 | 3.218 |
| 2 1/2 x 1 1/2 | 5.343 |
| 2 1/2 x 2 | 3.343 |
| 3 x 2 | 5.437 |
| 3 x 2 1/2 | 3.437 |
| 4 x 2 1/2 | 7.500 |
| 4 x 3 | 5.500 |

*Hex nut furnished

EG31CP - ADAPTER REDUCER (Concentric)

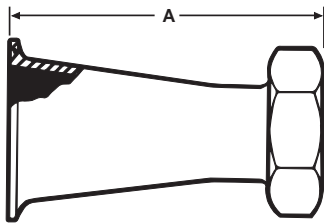

| Size Tube OD | A |
|-----------------|-------|
| 1 1/2 x 1 | 3.875 |
| 2 x 1 | 5.875 |
| 2 x 1 1/2 | 4.000 |
| 2 1/2 x 1 1/2 | 6.000 |
| 2 1/2 x 2 | 4.000 |
| 3 x 2 | 6.000 |
| 3 x 2 1/2 | 4.250 |
| 4 x 2 1/2 | 8.378 |
| 4 x 3 | 6.378 |

EG32CP - ADAPTER REDUCER (Eccentric)

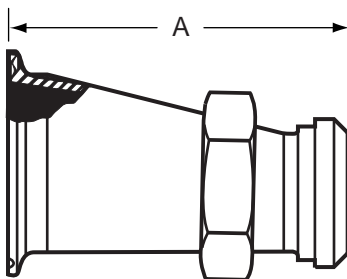

| Size Tube OD | A |
|-----------------|-------|
| 1 1/2 x 1 | 3.875 |
| 2 x 1 | 5.875 |
| 2 x 1 1/2 | 4.000 |
| 2 1/2 x 1 1/2 | 6.000 |
| 2 1/2 x 2 | 4.000 |
| 3 x 2 | 6.000 |
| 3 x 2 1/2 | 4.250 |
| 4 x 2 1/2 | 8.378 |
| 4 x 3 | 6.378 |

Note: One inch fittings take 1 1/2" clamps.
Fractional fittings take 3/4" clamps.

EG31TC - ADAPTER REDUCER (Concentric)

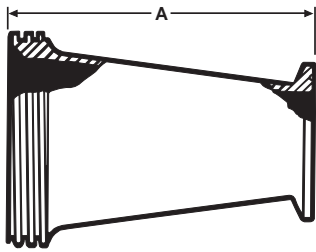

| Size Tube OD | A |
|-----------------|-------|
| 1 1/2 x 1 | 3.187 |
| 2 x 1 | 5.218 |
| 2 x 1 1/2 | 3.218 |
| 2 1/2 x 1 1/2 | 5.343 |
| 2 1/2 x 2 | 3.343 |
| 3 x 2 | 5.437 |
| 3 x 2 1/2 | 3.437 |
| 4 x 2 1/2 | 7.500 |
| 4 x 3 | 5.500 |

EG32TC - ADAPTER REDUCER (Eccentric)

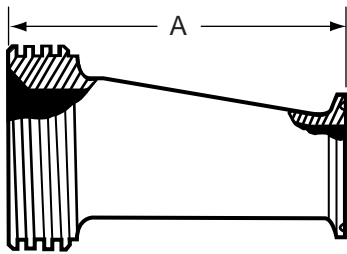

| Size Tube OD | A |
|-----------------|-------|
| 1 1/2 x 1 | 3.187 |
| 2 x 1 | 5.218 |
| 2 x 1 1/2 | 3.218 |
| 2 1/2 x 1 1/2 | 5.343 |
| 2 1/2 x 2 | 3.343 |
| 3 x 2 | 5.437 |
| 3 x 2 1/2 | 3.437 |
| 4 x 2 1/2 | 7.500 |
| 4 x 3 | 5.500 |

EG31CT - ADAPTER REDUCER (Concentric)

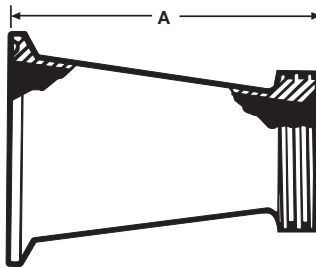

| Size Tube OD | A |
|-----------------|-------|
| 1 1/2 x 1 | 3.187 |
| 2 x 1 | 5.187 |
| 2 x 1 1/2 | 3.187 |
| 2 1/2 x 1 1/2 | 5.187 |
| 2 1/2 x 2 | 3.218 |
| 3 x 1 1/2 | 7.187 |
| 3 x 2 | 5.218 |
| 3 x 2 1/2 | 3.343 |
| 4 x 2 | 9.343 |
| 4 x 2 1/2 | 7.468 |
| 4 x 3 | 5.562 |

Note: One inch fittings take 1 1/2" clamps.
Fractional fittings take 3/4" clamps.

EG32CT - ADAPTER REDUCER (Eccentric)

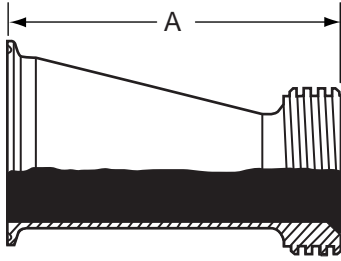

| Size Tube OD | A |
|-----------------|-------|
| 1 1/2 x 1 | 3.187 |
| 2 x 1 | 5.187 |
| 2 x 1 1/2 | 3.187 |
| 2 1/2 x 1 1/2 | 5.187 |
| 2 1/2 x 2 | 3.218 |
| 3 x 1 1/2 | 7.187 |
| 3 x 2 | 5.218 |
| 3 x 2 1/2 | 3.343 |
| 4 x 2 | 9.343 |
| 4 x 2 1/2 | 7.468 |
| 4 x 3 | 5.562 |

CLAMP FITTINGS SCHEDULE 5 & 10

EG2CS-5-6L - FERRULE

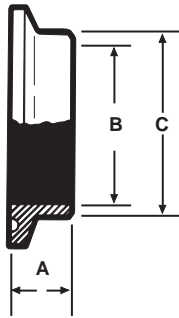

| Size Pipe | A | B | C | Nom. Wall |
|--------------|-------|-------|-------|-----------|
| 1 | 0.500 | 1.185 | 1.315 | 0.065 |
| 1 1/2 | 0.500 | 1.770 | 1.900 | 0.065 |
| 2 | 0.500 | 2.245 | 2.375 | 0.065 |
| 2 1/2 | 0.500 | 2.709 | 2.875 | 0.083 |
| 3 | 0.500 | 3.334 | 3.500 | 0.083 |
| 4 | 0.625 | 4.334 | 4.500 | 0.083 |

EG2CS-10-6L - FERRULE

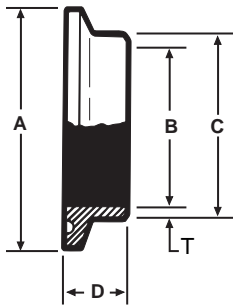

| Size Pipe | A | B | C | D | Nom. Wall |
|--------------|-------|-------|-------|-------|-----------|
| 1/2 | 1.984 | 0.674 | 0.840 | 0.500 | 0.083 |
| 3/4 | 1.984 | 0.884 | 1.050 | 0.500 | 0.083 |
| 1 | 1.984 | 1.097 | 1.315 | 0.500 | 0.109 |
| 1 1/2 | 2.516 | 1.682 | 1.900 | 0.500 | 0.109 |
| 2 | 3.047 | 2.157 | 2.375 | 0.500 | 0.109 |
| 2 1/2 | 3.579 | 2.635 | 2.875 | 0.500 | 0.120 |
| 3 | 4.125 | 3.260 | 3.500 | 0.500 | 0.120 |
| 4 | 5.125 | 4.260 | 4.500 | 0.625 | 0.120 |

CLAMP FITTINGS SCHEDULE 5 & 10

STAINLESS STEEL FITTINGS
PRODUCT CATALOG

EG14AM7-5-6L - FERRULE

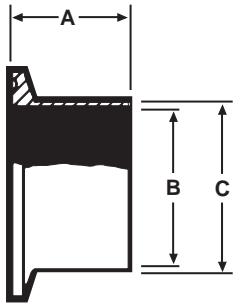

| Size Pipe | A | B | C | Nom. Wall |
|-----------|-------|-------|-------|-----------|
| 1 | 1.125 | 1.185 | 1.315 | 0.065 |
| 1 1/2 | 1.125 | 1.770 | 1.900 | 0.065 |
| 2 | 1.125 | 2.245 | 2.375 | 0.065 |
| 2 1/2 | 1.125 | 2.709 | 2.875 | 0.083 |
| 3 | 1.125 | 3.334 | 3.500 | 0.083 |
| 4 | 1.125 | 4.334 | 4.500 | 0.083 |

EG14AM7-10-6L - FERRULE

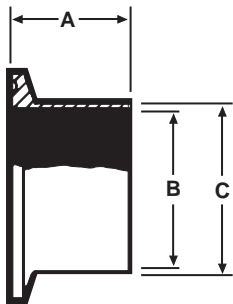

| Size Pipe | A | B | C | Nom. Wall |
|-----------|-------|-------|-------|-----------|
| 1 | 1.125 | 1.097 | 1.315 | 0.109 |
| 1 1/2 | 1.125 | 1.682 | 1.900 | 0.109 |
| 2 | 1.125 | 2.157 | 2.375 | 0.109 |
| 2 1/2 | 1.125 | 2.635 | 2.875 | 0.120 |
| 3 | 1.125 | 3.260 | 3.500 | 0.120 |
| 4 | 1.125 | 4.260 | 4.500 | 0.120 |

EG16A-5-6L - CAP



| Size Pipe | A | B |
|-----------|-------|-------|
| 1 | 1.984 | 0.250 |
| 1 1/2 | 2.516 | 0.250 |
| 2 | 3.047 | 0.250 |
| 2 1/2 | 3.579 | 0.250 |
| 3 | 4.125 | 0.250 |
| 4 | 5.125 | 0.250 |

13MHM-5 - CLAMP

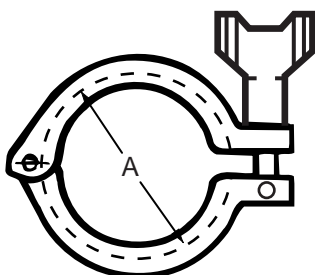

| Size Pipe | A |
|-----------|-------|
| 1 | 2.122 |
| 1 1/2 | 2.654 |
| 2 | 3.185 |
| 2 1/2 | 3.717 |
| 3 | 4.250 |
| 4 | 5.250 |

*PSI SERVICE RATINGS FOR SANITARY STAINLESS STEEL CLAMPS

| Pipe Size | 13MHHM | |
|-----------|--------|--------|
| | @70°F | @250°F |
| 1" | 500 | 250 |
| 1 1/2" | 450 | 250 |
| 2" | 400 | 200 |
| 2 1/2" | 350 | 150 |
| 3" | 250 | 135 |
| 4" | 175 | 100 |

GASKETS



| Gasket Materials | Part Number |
|------------------|--------------|
| Buna N | EG40-5-SIZE |
| Teflon | EG40T-5-SIZE |
| Viton | EG40V-5-SIZE |
| Silicone | EG40S-5-SIZE |
| EPDM | EG40E-5-SIZE |

Available in 1" to 4" sizes.

**Note: One inch fittings take 1 1/2" clamps.
Fractional fittings take 3/4" clamps.**

FITTINGS



Weld Fittings



WELD FITTINGS....

Weld Fittings are used on permanent installations where process piping and equipment can be cleaned in place (CIP) and removal from the system is not required. Weld Fittings are offered in nominal tube sizes 1/2" through 8" in T304 and T316L materials. Uniform wall thickness for 1/2" through 3" sizes measure .065 (16 ga). In 4" size, wall thickness measures .083 (14 ga), 6" and 8" .109 (12 ga).

VNE offers Polished ID and OD Fittings for immediate shipment. Other polished combinations may be ordered. Our Weld Fittings meet all 3A requirements.

WELD FITTING SPECIFICATIONS....

Size Range: 1/2" OD through 8" OD

Materials: T304
T316L

Finish: No. 7 - ID & OD
No. 5 - OD only
No. 3 - ID only
No. 1 - unpolished

ORDERING SPECIFICATIONS....

Specify:

- Quantity
- Product description or Part No.
- Size
- Material Type
- Polish Requirements

LIMITED WARRANTY....

VNE Corporation products are warranted to be free from defects in material and workmanship for a period of one year from the date of shipment. Any product that proves to be defective shall be repaired or replaced at the option of VNE, providing it has been used as recommended and in strict accordance with recognized piping practices, and that has not been subject to extraordinary service, such as encountered under severe corrosive or abrasive conditions.

VNE makes no warranties, express or implied, other than those listed above.

VNE shall not be liable for any consequential, indirect, incidental or contingent damages.

VNE CORPORATION

P.O. Box 1698 • 1149 Barberry Drive • Janesville, WI 53547

TEL: 608-756-4930 • FAX: 608-756-3643 • 1-800-356-1111 • Web site: vnestainless.com

WELD FITTINGS

| VNE | TRI-CLOVER | WAUKESHA | G & H | JENSEN |
|---------|------------|----------|---------|---------|
| E2S | L2S | 2CW | G2S | J2S |
| E2C | L2CM | 2CKW | G2C | J2CM |
| E2T | L2C | 2TW | G2T | J2C |
| E2F | L2F | 2FW | G2F | J2F |
| E2KS | L2KS | 2KW | G2KS | J2KS |
| E2KC | L2KM | 2KKW | G2KC | J2KM |
| E2KT | L2K | 2KT | G2KT | J2K |
| E2KP | L2P | 2KP | G2KP | J2P |
| E2WU | L2WU | 2WU | G2WU | J2WU |
| E7WWW | L7WWW | 7W | G7WWW | J7WWW |
| E7WWC | L7WWM | 7WWK | G7WWC | J7WWM |
| E7WWT | L7WWT | 7WWT | G7WWT | J7WWT |
| E7WCW | L7WMW | 7WKW | G7WCW | J7WMW |
| E7WTW | L7WTW | 7WTW | G7WTW | J7WTW |
| E7WCC | L7WMM | 7WKK | G7WCC | J7WMM |
| E7WTT | L7WTT | 7WTT | G7WTT | J7WTT |
| E7CCW | L7MMW | 7KKW | G7CCW | J7MMW |
| E7TTW | L7TTW | 7TTW | G7TTW | J7TTW |
| E7RWWW | L7RWWW | 7WR | G7RWWW | J7RWWW |
| E9WWWWW | L9WWWWW | 9W | G9WWWWW | J9WWWWW |
| E31WW | L31 | 31W | G31 | J31 |
| E32WW | L32 | 32W | G32 | J32 |
| E28WA | L28WA | 28WA | G28WA | J28WA |
| E28WB | L28WB | 28WB | G28WB | J28WB |

2WCL - 90° ELBOW SHORT TANGENT

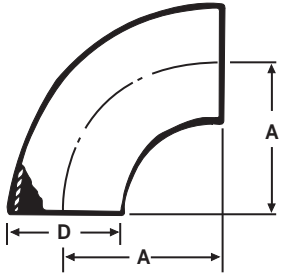

| Size Tube OD | A | D | Nom. Wall |
|-----------------|--------|-------|-----------|
| 1 | 1.500 | 1.000 | 0.065 |
| 1 1/4 | 1.875 | 1.250 | 0.065 |
| 1 1/2 | 2.250 | 1.500 | 0.065 |
| 2 | 3.000 | 2.000 | 0.065 |
| 2 1/2 | 3.750 | 2.500 | 0.065 |
| 3 | 4.500 | 3.000 | 0.065 |
| 4 | 6.000 | 4.000 | 0.083 |
| 6 | 9.000 | 6.000 | 0.109 |
| 8 | 12.000 | 8.000 | 0.109 |

E2S - 90° ELBOW

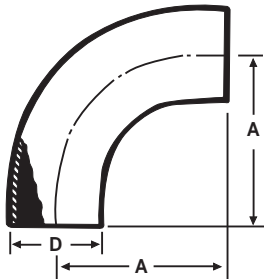

| Size Tube OD | A | D | Nom. Wall |
|-----------------|-------|-------|-----------|
| 1 | 2.062 | 1.000 | 0.065 |
| 1 1/2 | 2.937 | 1.500 | 0.065 |
| 2 | 4.062 | 2.000 | 0.065 |
| 2 1/2 | 5.187 | 2.500 | 0.065 |
| 3 | 6.312 | 3.000 | 0.065 |
| 4 | 8.312 | 4.000 | 0.083 |

E2C - 90° ELBOW

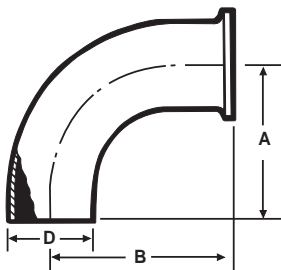

| Size Tube OD | A | B | D | Nom. Wall |
|-----------------|-------|-------|-------|-----------|
| 1 | 2.062 | 2.562 | 1.000 | 0.065 |
| 1 1/2 | 2.935 | 3.437 | 1.500 | 0.065 |
| 2 | 4.062 | 4.562 | 2.000 | 0.065 |
| 2 1/2 | 5.187 | 5.687 | 2.500 | 0.065 |
| 3 | 6.312 | 6.812 | 3.000 | 0.065 |
| 4 | 8.312 | 8.937 | 4.000 | 0.083 |
| 6 | 9.000 | 9.875 | 6.000 | 0.109 |

E2F - 90° ELBOW

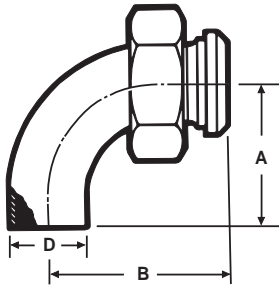

| Size Tube OD | A | B | D | Nom. Wall |
|-----------------|-------|-------|-------|-----------|
| 1 | 2.062 | 2.750 | 1.000 | 0.065 |
| 1 1/2 | 2.937 | 3.656 | 1.500 | 0.065 |
| 2 | 4.062 | 4.781 | 2.000 | 0.065 |
| 2 1/2 | 5.187 | 6.031 | 2.500 | 0.065 |
| 3 | 6.937 | 7.218 | 3.000 | 0.065 |
| 4 | 8.937 | 9.531 | 4.000 | 0.083 |

E2T - 90° ELBOW

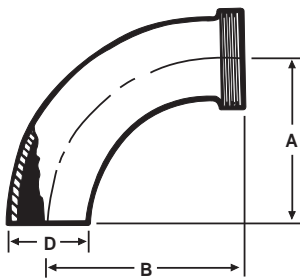

| Size Tube OD | A | B | D | Nom. Wall |
|-----------------|-------|-------|-------|-----------|
| 1 | 2.062 | 2.750 | 1.000 | 0.065 |
| 1 1/2 | 2.937 | 3.656 | 1.500 | 0.065 |
| 2 | 4.062 | 4.781 | 2.000 | 0.065 |
| 2 1/2 | 5.187 | 6.031 | 2.500 | 0.065 |
| 3 | 6.937 | 7.218 | 3.000 | 0.065 |
| 4 | 8.937 | 9.531 | 4.000 | 0.083 |

E2WU - 180° U BEND

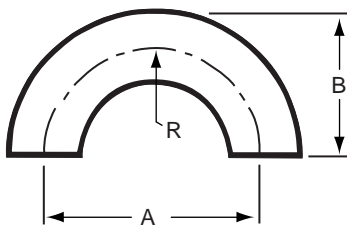

| Size Tube OD | A | B | C | R | Nom. Wall |
|-----------------|--------|--------|-------|-------|-----------|
| 1/2 | 1.500 | 1.000 | 0.500 | 0.750 | 0.065 |
| 3/4 | 2.250 | 1.500 | 0.750 | 1.125 | 0.065 |
| 1 | 3.000 | 2.000 | 1.000 | 1.500 | 0.065 |
| 1 1/4 | 3.750 | 2.500 | 1.250 | 1.875 | 0.065 |
| 1 1/2 | 4.500 | 3.000 | 1.500 | 2.250 | 0.065 |
| 2 | 6.000 | 4.000 | 2.000 | 3.000 | 0.065 |
| 2 1/2 | 7.500 | 5.000 | 2.500 | 3.750 | 0.065 |
| 3 | 9.000 | 6.000 | 3.000 | 4.500 | 0.065 |
| 4 | 12.000 | 8.000 | 4.000 | 6.000 | 0.083 |
| 6 | 18.000 | 12.000 | 6.000 | 9.000 | 0.109 |

E2WK - 45° ELBOW SHORT TANGENT

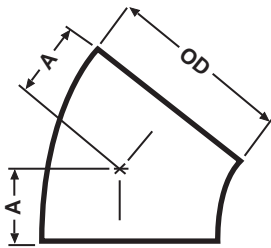

| Size Tube OD | A | Nom. Wall |
|-----------------|-------|-----------|
| 1/2 | 0.312 | 0.065 |
| 3/4 | 0.468 | 0.065 |
| 1 | 0.625 | 0.065 |
| 1 1/4 | 0.781 | 0.065 |
| 1 1/2 | 0.937 | 0.065 |
| 2 | 1.250 | 0.065 |
| 2 1/2 | 1.562 | 0.065 |
| 3 | 1.875 | 0.065 |
| 4 | 2.500 | 0.083 |
| 6 | 3.750 | 0.109 |
| 8 | 5.000 | 0.109 |

E2KS - 45° ELBOW

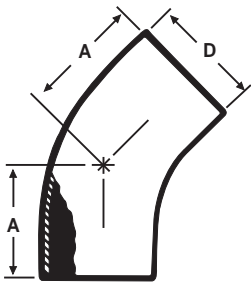

| Size Tube OD | A | D | Nom. Wall |
|-----------------|-------|-------|-----------|
| 1 | 1.187 | 1.000 | 0.065 |
| 1 1/2 | 1.625 | 1.500 | 0.065 |
| 2 | 2.312 | 2.000 | 0.065 |
| 2 1/2 | 3.000 | 2.500 | 0.065 |
| 3 | 3.687 | 3.000 | 0.065 |
| 4 | 4.812 | 4.000 | 0.083 |

E2KC - 45° ELBOW

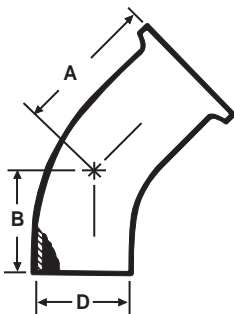

| Size Tube OD | A | B | D | Nom. Wall |
|-----------------|-------|-------|-------|-----------|
| 1 | 1.687 | 1.187 | 1.000 | 0.065 |
| 1 1/2 | 2.125 | 1.625 | 1.500 | 0.065 |
| 2 | 2.812 | 2.312 | 2.000 | 0.065 |
| 2 1/2 | 3.500 | 3.000 | 2.500 | 0.065 |
| 3 | 4.187 | 3.687 | 3.000 | 0.065 |
| 4 | 5.437 | 4.812 | 4.000 | 0.083 |
| 6 | 4.625 | 3.750 | 6.000 | 0.109 |

E2KT - 45° ELBOW

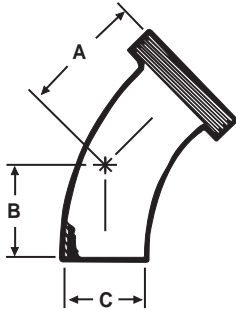

| Size Tube OD | A | B | C | Nom. Wall |
|-----------------|-------|-------|-------|-----------|
| 1 | 1.875 | 1.187 | 1.000 | 0.065 |
| 1 1/2 | 2.343 | 1.625 | 1.500 | 0.065 |
| 2 | 3.031 | 2.312 | 2.000 | 0.065 |
| 2 1/2 | 3.843 | 3.000 | 2.500 | 0.065 |
| 3 | 4.593 | 3.687 | 3.000 | 0.065 |
| 4 | 6.031 | 4.812 | 4.000 | 0.083 |

E2KP - 45° ELBOW

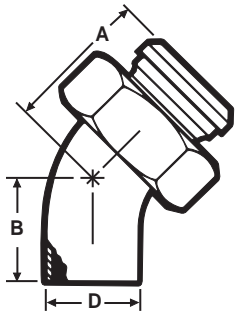

| Size Tube OD | A | B | D | Nom. Wall |
|-----------------|-------|-------|-------|-----------|
| 1 | 1.875 | 1.187 | 1.000 | 0.065 |
| 1 1/2 | 2.343 | 1.625 | 1.500 | 0.065 |
| 2 | 3.031 | 2.312 | 2.000 | 0.065 |
| 2 1/2 | 3.843 | 3.000 | 2.500 | 0.065 |
| 3 | 4.593 | 3.687 | 3.000 | 0.065 |
| 4 | 6.031 | 4.812 | 4.000 | 0.083 |

E7WWW - TEE

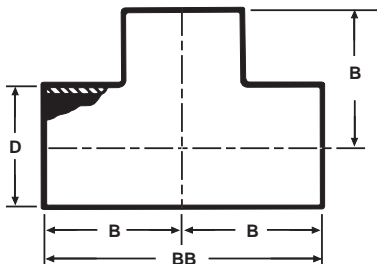

| Size Tube OD | B | BB | D | Nom. Wall |
|-----------------|-------|--------|-------|-----------|
| 1 | 1.125 | 2.250 | 1.000 | 0.065 |
| 1 1/4 | 2.250 | 4.500 | 1.250 | 0.065 |
| 1 1/2 | 1.656 | 3.312 | 1.500 | 0.065 |
| 2 | 2.062 | 4.125 | 2.000 | 0.065 |
| 2 1/2 | 2.343 | 4.687 | 2.500 | 0.065 |
| 3 | 2.593 | 5.187 | 3.000 | 0.065 |
| 4 | 3.437 | 6.875 | 4.000 | 0.083 |
| 6 | 5.625 | 11.250 | 6.000 | 0.109 |
| 8 | 7.000 | 14.000 | 8.000 | 0.109 |

E7RWWW - REDUCING TEE

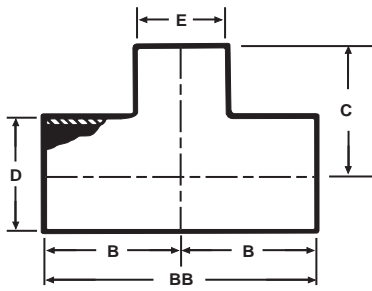

| Size Tube OD | B | BB | C | D | E | Nom. Wall |
|-----------------|-------|--------|-------|-------|-------|---------------|
| 1 1/2 x 1 | 1.656 | 3.312 | 1.375 | 1.500 | 1.000 | 0.065 |
| 1 1/2 x 1 1/4 | 2.250 | 4.500 | 2.250 | 1.500 | 1.250 | 0.065 |
| 2 x 1 | 2.062 | 4.125 | 1.906 | 2.000 | 1.000 | 0.065 |
| 2 x 1 1/2 | 2.062 | 4.125 | 1.906 | 2.000 | 1.500 | 0.065 |
| 2 1/2 x 1 | 2.343 | 4.681 | 3.125 | 2.500 | 1.000 | 0.065 |
| 2 1/2 x 1 1/2 | 2.343 | 4.687 | 3.125 | 2.500 | 1.500 | 0.065 |
| 2 1/2 x 2 | 2.343 | 4.687 | 2.312 | 2.500 | 2.000 | 0.065 |
| 3 x 1 | 2.593 | 5.189 | 2.906 | 3.000 | 1.000 | 0.065 |
| 3 x 1 1/2 | 2.293 | 5.189 | 2.906 | 3.000 | 1.500 | 0.065 |
| 3 x 2 | 2.593 | 5.187 | 2.562 | 3.000 | 2.000 | 0.065 |
| 3 X 2 1/2 | 2.593 | 5.187 | 2.562 | 3.000 | 2.500 | 0.065 |
| 4 x 1 1/2 | 3.437 | 6.875 | 4.906 | 4.000 | 1.500 | 0.083 x 0.065 |
| 4 x 2 | 3.437 | 6.875 | 5.062 | 4.000 | 2.000 | 0.083 x 0.065 |
| 4 x 2 1/2 | 3.437 | 6.875 | 5.093 | 4.000 | 2.500 | 0.083 x 0.065 |
| 4 x 3 | 3.437 | 6.875 | 5.093 | 4.000 | 3.000 | 0.083 x 0.065 |
| 6 x 2 | 5.625 | 11.250 | 5.625 | 6.000 | 2.000 | 0.109 x 0.065 |
| 6 x 3 | 5.625 | 11.250 | 5.625 | 6.000 | 3.000 | 0.109 x 0.065 |
| 6 x 4 | 5.625 | 11.250 | 5.625 | 6.000 | 4.000 | 0.109 x 0.083 |

E7WWCS - SHORT CLAMP BRANCH TEE

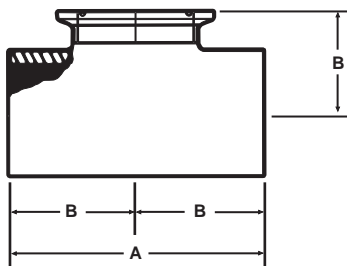

| Size Tube OD | A | B | Nom. Wall |
|-----------------|--------|-------|-----------|
| 1 | 4.250 | 2.125 | .065 |
| 1 1/2 | 4.750 | 2.375 | .065 |
| 2 | 5.750 | 2.875 | .065 |
| 2 1/2 | 6.250 | 3.125 | .065 |
| 3 | 6.750 | 3.375 | .065 |
| 4 | 8.250 | 4.125 | .083 |
| 6 | 11.250 | 5.625 | .109 |

E7RWWCS - REDUCING SHORT CLAMP BRANCH TEE

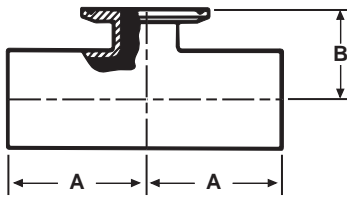

| Size Tube OD | A | B | Nom. Wall |
|-----------------|-------|-------|-----------|
| 3/4 x 1/2 | 2.000 | 1.000 | 0.065 |
| 1 x 1/2 | 2.120 | 1.120 | 0.065 |
| 1 x 3/4 | 2.120 | 1.120 | 0.065 |
| 1 1/2 x 1/2 | 2.370 | 1.370 | 0.065 |
| 1 1/2 x 3/4 | 2.370 | 1.370 | 0.065 |
| 1 1/2 x 1 | 2.370 | 1.370 | 0.065 |
| 2 x 1/2 | 2.870 | 1.620 | 0.065 |
| 2 x 3/4 | 2.870 | 1.620 | 0.065 |
| 2 x 1 | 2.870 | 1.620 | 0.065 |
| 2 x 1 1/2 | 2.870 | 1.620 | 0.065 |
| 2 1/2 x 1/2 | 3.120 | 1.870 | 0.065 |
| 2 1/2 x 3/4 | 3.120 | 1.870 | 0.065 |
| 2 1/2 x 1 | 3.120 | 1.870 | 0.065 |
| 2 1/2 x 1 1/2 | 3.120 | 1.870 | 0.065 |
| 2 1/2 x 2 | 3.120 | 1.870 | 0.065 |
| 3 x 1/2 | 3.370 | 2.120 | 0.065 |
| 3 x 3/4 | 3.370 | 2.120 | 0.065 |
| 3 x 1 | 3.370 | 2.120 | 0.065 |
| 3 x 1 1/2 | 3.370 | 2.120 | 0.065 |
| 3 x 2 | 3.370 | 2.120 | 0.065 |
| 3 x 2 1/2 | 3.370 | 2.120 | 0.065 |
| 4 x 1/2 | 4.120 | 2.620 | 0.083 |
| 4 x 3/4 | 4.120 | 2.620 | 0.083 |
| 4 x 1 | 4.120 | 2.620 | 0.083 |
| 4 x 1 1/2 | 4.120 | 2.620 | 0.083 |
| 4 x 2 | 4.120 | 2.620 | 0.083 |
| 4 x 2 1/2 | 4.120 | 2.620 | 0.083 |
| 4 x 3 | 4.120 | 2.620 | 0.083 |
| 6 x 4 | 5.630 | 3.750 | 0.109 |

E7WWC - TEE WELD X WELD X CLAMP

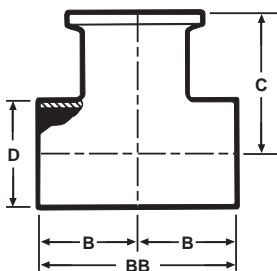

| Size Tube OD | B | BB | C | D | Nom. Wall |
|-----------------|-------|--------|-------|-------|-----------|
| 1 | 1.125 | 2.250 | 1.625 | 1.000 | 0.065 |
| 1 1/2 | 1.656 | 3.312 | 2.156 | 1.500 | 0.065 |
| 2 | 2.062 | 4.125 | 2.562 | 2.000 | 0.065 |
| 2 1/2 | 2.343 | 4.687 | 2.843 | 2.500 | 0.065 |
| 3 | 2.593 | 5.187 | 3.093 | 3.000 | 0.065 |
| 4 | 3.625 | 7.250 | 4.656 | 4.000 | 0.083 |
| 6 | 5.625 | 11.250 | 6.500 | 6.000 | 0.109 |

E7WWT - TEE WELD X WELD X THREAD

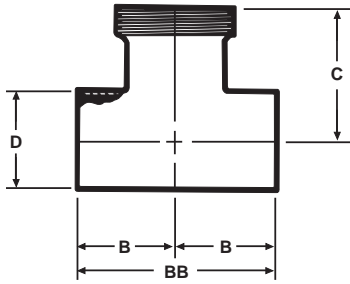

| Size Tube OD | B | BB | C | D | Nom. Wall |
|-----------------|-------|-------|-------|-------|-----------|
| 1 | 1.125 | 2.250 | 1.812 | 1.000 | 0.065 |
| 1 1/2 | 1.656 | 3.312 | 2.375 | 1.500 | 0.065 |
| 2 | 2.062 | 4.125 | 2.781 | 2.000 | 0.065 |
| 2 1/2 | 2.343 | 4.687 | 3.187 | 2.500 | 0.065 |
| 3 | 2.593 | 5.187 | 3.500 | 3.000 | 0.065 |
| 4 | 3.625 | 7.250 | 4.656 | 4.000 | 0.083 |

E7WCW - TEE WELD X CLAMP X WELD

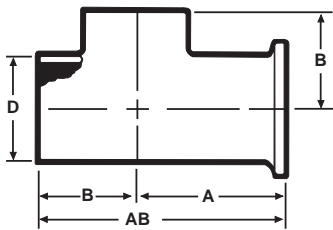

| Size Tube OD | A | B | AB | D | Nom. Wall |
|-----------------|-------|-------|--------|-------|-----------|
| 1 | 1.625 | 1.125 | 2.750 | 1.000 | 0.065 |
| 1 1/2 | 2.156 | 1.656 | 3.812 | 1.500 | 0.065 |
| 2 | 2.562 | 2.062 | 4.625 | 2.000 | 0.065 |
| 2 1/2 | 2.843 | 2.343 | 5.187 | 2.500 | 0.065 |
| 3 | 3.093 | 2.593 | 5.687 | 3.000 | 0.065 |
| 4 | 4.250 | 3.625 | 7.875 | 4.000 | 0.083 |
| 6 | 6.500 | 5.625 | 12.125 | 6.000 | 0.109 |

E7WTW - TEE THREADED ONE END - WELD X THREAD X WELD

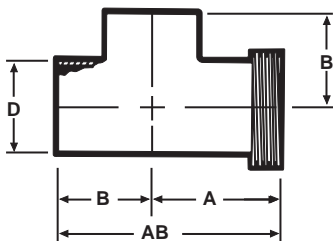

| Size Tube OD | A | B | AB | D | Nom. Wall |
|-----------------|-------|-------|-------|-------|-----------|
| 1 | 1.812 | 1.125 | 2.937 | 1.000 | 0.065 |
| 1 1/2 | 2.375 | 1.656 | 4.031 | 1.500 | 0.065 |
| 2 | 2.781 | 2.062 | 4.843 | 2.000 | 0.065 |
| 2 1/2 | 3.187 | 2.343 | 5.531 | 2.500 | 0.065 |
| 3 | 3.500 | 2.593 | 6.093 | 3.000 | 0.065 |
| 4 | 4.656 | 3.625 | 8.281 | 4.000 | 0.083 |

E7WCC - TEE WELD X CLAMP X CLAMP

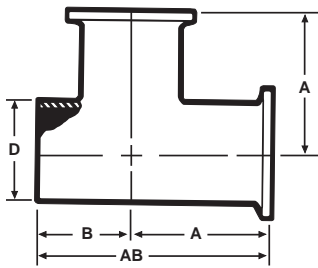

| Size Tube OD | A | B | AB | D | Nom. Wall |
|-----------------|-------|-------|--------|-------|-----------|
| 1 | 1.625 | 1.125 | 2.750 | 1.000 | 0.065 |
| 1 1/2 | 2.156 | 1.656 | 3.812 | 1.500 | 0.065 |
| 2 | 2.562 | 2.062 | 4.625 | 2.000 | 0.065 |
| 2 1/2 | 2.843 | 2.343 | 5.187 | 2.500 | 0.065 |
| 3 | 3.093 | 2.593 | 5.687 | 3.000 | 0.065 |
| 4 | 4.250 | 3.625 | 7.875 | 4.000 | 0.083 |
| 6 | 6.500 | 5.625 | 12.125 | 6.000 | 0.109 |

E7WTT - TEE WELD X THREAD X THREAD

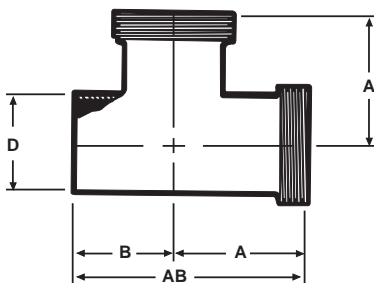

| Size Tube OD | A | B | AB | D | Nom. Wall |
|-----------------|-------|-------|-------|-------|-----------|
| 1 | 1.812 | 1.125 | 2.937 | 1.000 | 0.065 |
| 1 1/2 | 2.375 | 1.656 | 4.031 | 1.500 | 0.065 |
| 2 | 2.781 | 2.062 | 4.843 | 2.000 | 0.065 |
| 2 1/2 | 3.187 | 2.343 | 5.531 | 2.500 | 0.065 |
| 3 | 3.500 | 2.593 | 6.093 | 3.000 | 0.065 |
| 4 | 4.656 | 3.625 | 8.281 | 4.000 | 0.083 |

E7CCW - TEE CLAMP X CLAMP X WELD

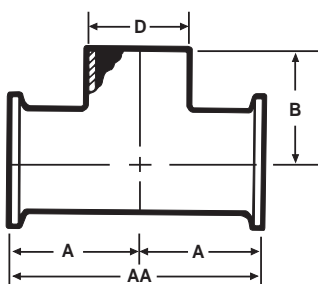

| Size Tube OD | A | AA | B | D | Nom. Wall |
|-----------------|-------|--------|-------|-------|-----------|
| 1 | 1.625 | 3.250 | 1.125 | 1.000 | 0.065 |
| 1 1/2 | 2.562 | 4.312 | 1.656 | 1.500 | 0.065 |
| 2 | 2.562 | 5.125 | 2.062 | 2.000 | 0.065 |
| 2 1/2 | 2.843 | 5.687 | 2.343 | 2.500 | 0.065 |
| 3 | 3.093 | 6.187 | 2.593 | 3.000 | 0.065 |
| 4 | 4.250 | 8.500 | 3.625 | 4.000 | 0.083 |
| 6 | 6.500 | 13.000 | 5.625 | 6.000 | 0.109 |

E7TTW - TEE THREAD X THREAD X WELD

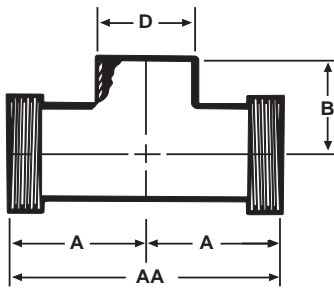

| Size Tube OD | A | AA | B | D | Nom. Wall |
|-----------------|-------|-------|-------|-------|-----------|
| 1 | 1.812 | 3.625 | 1.125 | 1.000 | 0.065 |
| 1 1/2 | 2.375 | 4.750 | 1.656 | 1.500 | 0.065 |
| 2 | 2.781 | 5.562 | 2.062 | 2.000 | 0.065 |
| 2 1/2 | 3.187 | 6.375 | 2.343 | 2.500 | 0.065 |
| 3 | 3.500 | 7.000 | 2.593 | 3.000 | 0.065 |
| 4 | 4.656 | 9.312 | 3.625 | 4.000 | 0.083 |

E9WWW - CROSS

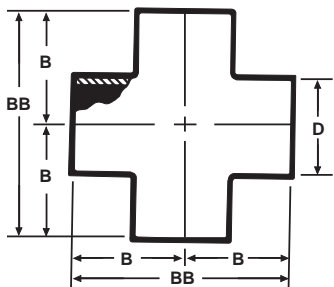

| Size Tube OD | B | BB | D | Nom. Wall |
|-----------------|-------|--------|-------|-----------|
| 1 | 1.125 | 2.250 | 1.000 | .065 |
| 1 1/2 | 1.656 | 3.312 | 1.500 | .065 |
| 2 | 2.062 | 4.125 | 2.000 | .065 |
| 2 1/2 | 2.343 | 4.687 | 2.500 | .065 |
| 3 | 2.593 | 5.187 | 3.000 | .065 |
| 4 | 3.437 | 6.875 | 4.000 | .083 |
| 6 | 5.625 | 11.250 | 6.000 | .109 |

E14WA - TYPE A STUB END WITH GROOVES

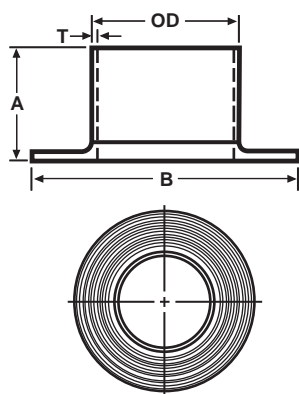

| Size Tube OD | A | B | Nom. Wall (T) |
|-----------------|-------|-------|--------------------|
| 1/2 | 1.375 | 1.625 | 0.065 |
| 3/4 | 1.375 | 1.687 | 0.065 |
| 1 | 1.625 | 2.000 | 0.065 |
| 1 1/4 | 1.625 | 2.500 | 0.065 |
| 1 1/2 | 1.750 | 2.875 | 0.065 |
| 2 | 1.500 | 3.625 | 0.065 |
| 2 1/2 | 2.000 | 4.125 | 0.065 |
| 3 | 2.000 | 5.000 | 0.065 |
| 4 | 2.625 | 6.187 | 0.083 |
| 6 | 3.000 | 8.500 | 0.109 |

E16W - WELD CAP

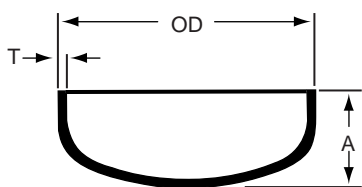

| Size Tube OD | A | Nom. Wall (T) |
|-----------------|-------|-----------------|
| 1 | 0.375 | 0.065 |
| 1 1/4 | 0.500 | 0.065 |
| 1 1/2 | 0.562 | 0.065 |
| 2 | 0.750 | 0.065 |
| 2 1/2 | 1.000 | 0.065 |
| 3 | 1.250 | 0.065 |
| 4 | 1.500 | 0.083 |
| 6 | 2.000 | 0.109 |

E28WA - 45° LATERAL

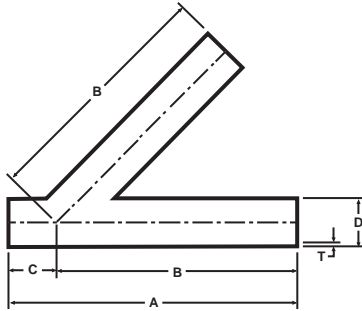

| Size Tube OD | A | B | C | D | Nom. Wall (T) |
|-----------------|--------|--------|-------|-------|------------------|
| 1 | 6.000 | 5.000 | 1.000 | 1.000 | 0.065 |
| 1 1/2 | 7.375 | 6.187 | 1.187 | 1.500 | 0.065 |
| 2 | 8.625 | 7.125 | 1.500 | 2.000 | 0.065 |
| 2 1/2 | 10.125 | 8.500 | 1.625 | 2.500 | 0.065 |
| 3 | 10.750 | 8.875 | 1.875 | 3.000 | 0.065 |
| 4 | 12.812 | 10.750 | 2.062 | 4.000 | 0.083 |
| 6 | 18.000 | 14.500 | 3.500 | 6.000 | 0.109 |

E28WB - TRUE Y

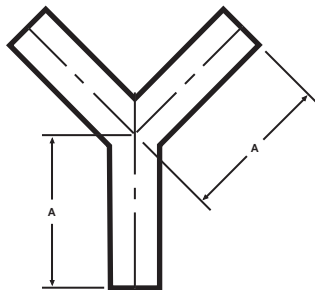

| Size Tube OD | A | Nom. Wall |
|-----------------|-------|-----------|
| 1 | 3.000 | 0.065 |
| 1 1/2 | 3.000 | 0.065 |
| 2 | 4.000 | 0.065 |
| 2 1/2 | 5.000 | 0.065 |
| 3 | 6.000 | 0.065 |
| 4 | 8.000 | 0.083 |
| 6 | 8.000 | 0.109 |

E28RWA - 45° REDUCING LATERAL

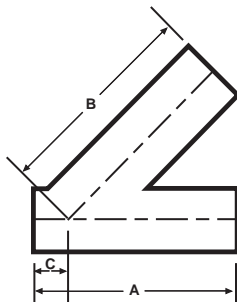

| Size Tube OD | A | B | C | Nom. Wall |
|-----------------|--------|--------|-------|--------------|
| 1 1/2 x 1 | 7.375 | 6.187 | 1.187 | 0.065 |
| 2 x 1 | 8.625 | 7.125 | 1.625 | 0.065 |
| 2 x 1 1/2 | 8.625 | 7.125 | 1.625 | 0.065 |
| 2 1/2 x 1 | 10.125 | 8.500 | 1.500 | 0.065 |
| 2 1/2 x 1 1/2 | 10.125 | 8.500 | 1.500 | 0.065 |
| 2 1/2 x 2 | 10.125 | 8.500 | 1.500 | 0.065 |
| 3 x 1 | 10.750 | 8.875 | 1.875 | 0.065 |
| 3 x 1 1/2 | 10.750 | 8.875 | 1.875 | 0.065 |
| 3 x 2 | 10.750 | 8.875 | 1.875 | 0.065 |
| 3 x 2 1/2 | 10.750 | 8.875 | 1.875 | 0.065 |
| 4 x 1 | 12.812 | 10.750 | 2.062 | 0.083 x .065 |
| 4 x 1 1/2 | 12.812 | 10.750 | 2.062 | 0.083 x .065 |
| 4 x 2 | 12.812 | 10.750 | 2.062 | 0.083 x .065 |
| 4 x 2 1/2 | 12.812 | 10.750 | 2.062 | 0.083 x .065 |
| 4 x 3 | 12.812 | 10.750 | 2.062 | 0.083 x .065 |

E31WW - CONCENTRIC REDUCER

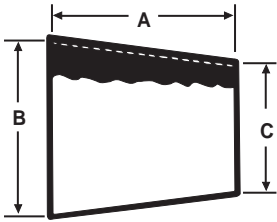

| Size Tube OD | A | B | C | Nom. Wall |
|-----------------|-------|-------|-------|--------------|
| 3/4 x 1/2 | * | 0.750 | 0.500 | 0.065 |
| 1 x 1/2 | * | 1.000 | 0.500 | 0.065 |
| 1 x 3/4 | * | 1.000 | 0.750 | 0.065 |
| 1 1/2 x 1/2 | * | 1.500 | 0.500 | 0.065 |
| 1 1/2 x 3/4 | * | 1.500 | 0.750 | 0.065 |
| 1 1/2 x 1 | 2.000 | 1.500 | 1.000 | 0.065 |
| 1 1/2 x 1 1/4 | 1.000 | 1.500 | 1.250 | 0.065 |
| 2 x 1 | 4.000 | 2.000 | 1.000 | 0.065 |
| 2 x 1 1/4 | 3.000 | 2.000 | 1.250 | 0.065 |
| 2 x 1 1/2 | 2.000 | 2.000 | 1.500 | 0.065 |
| 2 1/2 x 1 1/2 | 4.000 | 2.500 | 1.500 | 0.065 |
| 2 1/2 x 2 | 2.000 | 2.500 | 2.000 | 0.065 |
| 3 x 1 1/2 | 6.000 | 3.000 | 1.500 | 0.065 |
| 3 x 2 | 4.000 | 3.000 | 2.000 | 0.065 |
| 3 x 2 1/2 | 2.000 | 3.000 | 2.500 | 0.065 |
| 4 x 2 | 8.000 | 4.000 | 2.000 | 0.083 x .065 |
| 4 x 2 1/2 | 6.000 | 4.000 | 2.500 | 0.083 x .065 |
| 4 x 3 | 4.000 | 4.000 | 3.000 | 0.083 x .065 |
| 6 x 2 | 5.500 | 6.000 | 2.000 | 0.109 x .065 |
| 6 x 3 | 5.500 | 6.000 | 3.000 | 0.109 x .083 |
| 6 x 4 | 5.500 | 6.000 | 4.000 | 0.109 x .083 |

* Contact VNE for dimensions.

E31CW - CONCENTRIC REDUCER CLAMP X WELD

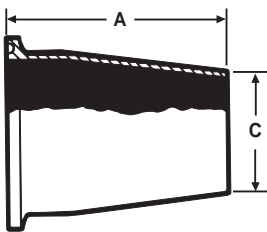

| Size Tube OD | A | C | Nom. Wall |
|-----------------|-------|-------|-----------|
| 1 1/2 x 1 | 2.500 | 1.000 | 0.065 |
| 2 x 1 1/2 | 2.500 | 1.500 | 0.065 |
| 2 1/2 x 1 1/2 | 4.500 | 1.500 | 0.065 |
| 2 1/2 x 2 | 2.500 | 2.000 | 0.065 |
| 3 x 2 | 4.500 | 2.000 | 0.065 |
| 3 x 2 1/2 | 2.500 | 2.500 | 0.065 |
| 4 x 2 | 8.625 | 2.000 | 0.065 |
| 4 x 2 1/2 | 6.625 | 2.500 | 0.065 |
| 4 x 3 | 4.625 | 3.000 | 0.065 |
| 6 x 4 | 6.375 | 4.000 | 0.083 |

E31PW - CONCENTRIC REDUCER PLAIN BEVEL X WELD

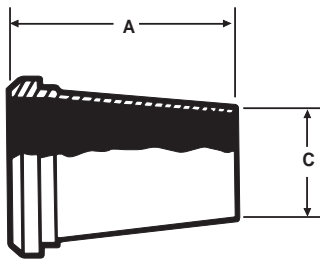

| Size Tube OD | A | C | Nom. Wall |
|-----------------|-------|-------|-----------|
| 1 1/2 x 1 | 2.687 | 1.000 | 0.065 |
| 2 x 1 1/2 | 2.718 | 1.500 | 0.065 |
| 2 1/2 x 1 1/2 | 4.843 | 1.500 | 0.065 |
| 2 1/2 x 2 | 2.843 | 2.000 | 0.065 |
| 3 x 2 | 4.937 | 2.000 | 0.065 |
| 3 x 2 1/2 | 2.937 | 2.500 | 0.065 |
| 4 x 2 | 9.000 | 2.000 | 0.065 |
| 4 x 2 1/2 | 7.000 | 2.500 | 0.065 |
| 4 x 3 | 5.000 | 3.000 | 0.065 |

E32WW - ECCENTRIC REDUCER

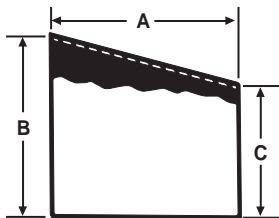

| Size Tube OD | A | B | C | Nom. Wall |
|-----------------|-------|-------|-------|--------------|
| 3/4 x 1/2 | * | 0.750 | 0.500 | 0.065 |
| 1 x 1/2 | * | 1.000 | 0.500 | 0.065 |
| 1 x 3/4 | * | 1.000 | 0.750 | 0.065 |
| 1 1/2 x 1/2 | * | 1.500 | 0.500 | 0.065 |
| 1 1/2 x 3/4 | * | 1.500 | 0.750 | 0.065 |
| 1 1/2 x 1 | 2.000 | 1.500 | 1.000 | 0.065 |
| 1 1/2 x 1 1/4 | 1.000 | 1.500 | 1.250 | 0.065 |
| 2 x 1 | 4.000 | 2.000 | 1.250 | 0.065 |
| 2 x 1 1/4 | 3.000 | 2.000 | 1.250 | 0.065 |
| 2 x 1 1/2 | 2.000 | 2.000 | 1.500 | 0.065 |
| 2 1/2 x 1 1/2 | 4.000 | 2.500 | 1.500 | 0.065 |
| 2 1/2 x 2 | 2.000 | 2.500 | 2.000 | 0.065 |
| 3 x 2 | 4.000 | 3.000 | 2.000 | 0.065 |
| 3 x 2 1/2 | 2.000 | 3.000 | 2.500 | 0.065 |
| 4 x 2 | 8.000 | 4.000 | 2.000 | 0.083 x .065 |
| 4 x 2 1/2 | 6.000 | 4.000 | 2.500 | 0.083 x .065 |
| 4 x 3 | 4.000 | 4.000 | 3.000 | 0.083 x .065 |
| 6 x 2 | 5.500 | 6.000 | 2.000 | 0.109 x .065 |
| 6 x 3 | 5.500 | 6.000 | 3.000 | 0.109 x .083 |
| 6 x 4 | 5.500 | 6.000 | 4.000 | 0.109 x .083 |

* Contact VNE for dimensions.

E32CW - ECCENTRIC REDUCER CLAMP X WELD

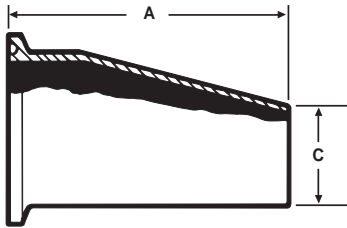

| Size Tube OD | A | C | Nom. Wall |
|-----------------|-------|-------|-----------|
| 1 1/2 X 1 | 2.500 | 1.000 | 0.065 |
| 2 x 1 1/2 | 2.500 | 1.500 | 0.065 |
| 2 1/2 x 1 1/2 | 4.500 | 1.500 | 0.065 |
| 2 1/2 x 2 | 2.500 | 2.000 | 0.065 |
| 3 x 2 | 4.500 | 2.000 | 0.065 |
| 3 x 2 1/2 | 2.500 | 2.500 | 0.065 |
| 4 x 2 | 8.625 | 2.000 | 0.065 |
| 4 x 2 1/2 | 6.625 | 2.500 | 0.065 |
| 4 x 3 | 4.625 | 3.000 | 0.065 |
| 6 x 4 | 6.375 | 4.000 | 0.083 |

E17WW-6L - TUBE X PIPE ADAPTER

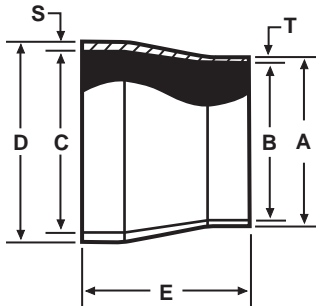

| Size Tube OD | A | B | SCH5 C | SCH10 C | SCH40 C | D |
|-----------------|-------|-------|-----------|------------|------------|-------|
| 1/2 | 0.500 | 0.370 | 0.710 | 0.674 | 0.622 | 0.840 |
| 3/4 | 0.750 | 0.620 | 0.920 | 0.884 | 0.824 | 1.050 |
| 1 | 1.000 | 0.870 | 1.185 | 1.097 | 1.049 | 1.315 |
| 1 1/2 | 1.500 | 1.370 | 1.770 | 1.682 | 1.610 | 1.900 |
| 2 | 2.000 | 1.870 | 2.245 | 2.157 | 2.067 | 2.375 |
| 2 1/2 | 2.500 | 2.370 | 2.709 | 2.635 | 2.469 | 2.875 |
| 3 | 3.000 | 2.870 | 3.334 | 3.260 | 3.068 | 3.500 |
| 4 | 4.000 | 3.834 | 4.334 | 4.260 | 4.026 | 4.500 |
| 6 | 6.000 | 5.782 | 6.407 | 6.357 | 6.065 | 6.625 |

| Size Tube OD | E | T | SCH5 S | SCH10 S | SCH40 S |
|-----------------|-------|-------|-----------|------------|------------|
| 1/2 | 1.000 | 0.065 | 0.065 | 0.083 | 0.109 |
| 3/4 | 1.000 | 0.065 | 0.065 | 0.083 | 0.113 |
| 1 | 1.000 | 0.065 | 0.065 | 0.109 | 0.133 |
| 1 1/2 | 1.500 | 0.065 | 0.065 | 0.109 | 0.145 |
| 2 | 1.500 | 0.065 | 0.065 | 0.109 | 0.154 |
| 2 1/2 | 1.500 | 0.065 | 0.083 | 0.120 | 0.203 |
| 3 | 2.000 | 0.065 | 0.083 | 0.120 | 0.216 |
| 4 | 2.000 | 0.083 | 0.083 | 0.120 | 0.237 |
| 6 | 3.000 | 0.109 | 0.109 | 0.134 | 0.280 |

FITTINGS



**Bevel Seat Fittings
John Perry Fittings**



BEVEL SEAT FITTINGS....

Bevel Seat Fittings are used on process equipment and piping to ensure rigidity of the system. Bevel Seat Unions consist of a Threaded Bevel Ferrule mated with a Plain Bevel Ferrule. Both are offered in T304 and T316L material. Hex Union Nuts made of only T304 material are used to complete the union. Gaskets for VNE's Bevel Seat Unions are not required for positive shut-off. However, gaskets may be purchased upon request.

VNE's Bevel Seat Fittings meet all 3A requirements and are available in 1" through 4" sizes.

BEVEL SEAT SPECIFICATIONS....

Size Range: 1" OD through 4" OD

Materials: T304
T316L

Finish: No. 7 - ID & OD
No. 5 - OD only
No. 3 - ID only
No. 1 - unpolished

ORDERING SPECIFICATIONS....

Specify:

- Quantity
- Product description or Part No.
- Size
- Material Type
- Polish Requirements

LIMITED WARRANTY....

VNE Corporation products are warranted to be free from defects in material and workmanship for a period of one year from the date of shipment. Any product that proves to be defective shall be repaired or replaced at the option of VNE, providing it has been used as recommended and in strict accordance with recognized piping practices, and that has not been subject to extraordinary service, such as encountered under severe corrosive or abrasive conditions.

VNE makes no warranties, express or implied, other than those listed above.

VNE shall not be liable for any consequential, indirect, incidental or contingent damages.

VNE CORPORATION

P.O. Box 1698 • 1149 Barberry Drive • Janesville, WI 53547

TEL: 608-756-4930 • FAX: 608-756-3643 • 1-800-356-1111 • Web site: vnestainless.com

BEVEL SEAT TYPE

| VNE | TRI-CLOVER | WAUKESHA | G & H | JENSEN |
|--------|------------|----------|--------|--------|
| 2C | 2C | 2C | 2C | 2C |
| 2E | 2E | 2E | 2E | 2E |
| 2F | 2F | 2F | 2F | 2F |
| 2F-31 | 2F-31 | 2F-31 | 2F-31 | 2F-31 |
| 2K | 2K | 2K | 2K | 2K |
| 2P | 2P | 2P | 2P | 2P |
| 7 | 7 | 7 | 7 | 7 |
| 7A | 7A | 7A | 7A | 7A |
| 7B | 7B | 7B | 7B | 7B |
| 9 | 9 | 9 | 9 | 9 |
| 9A | 9A | 9A | 9A | 9A |
| 13H | 13H | 13H | 13H | 13H |
| 14 | 14 | 14 | 14 | 14 |
| 14A | L14A7 | 14A | G14A | 14A |
| 14AHR | 14AHR | 14AHR | 14AHR | 14AHR |
| 14AHT | 14AHT | 14AHT | 14AHT | 14AHT |
| 14R | 14R | 14R | 14R | 14R |
| 14W | 14W | 14W | 14W | 14W |
| 14-22 | 14-22 | 14-22 | 14-22 | 14-18 |
| 14WL | 14WL | 14WL | 14WL | 14WL |
| 14-19 | 14-19 | 21F | 21F | 14-19 |
| 14PR | 14PRF | 14RW | S2FS | 14++ |
| 15 | 15 | 15 | 15 | 15 |
| 15TR | 15TRF | 15RW | S2CS | 15++ |
| 15A | L15A7 | 15A | G15A | 15A |
| 15AHR | 15AHR | 15AHR | 15AHR | 15AHR |
| 15AHT | 15AHT | 15AHT | 15AHT | 15AHT |
| 15R | 15R | 15R | 15R | 15R |
| 15W | 15W | 15W | 15W | 15W |
| 15WL | 15WL | 15WL | 15WL | 15WL |
| 16A | 16A | 16A | 16A | 16A |
| 21 | 21 | 21 | 21 | 21 |
| 23B | 23B | 23B | 23B | 23B |
| 22 | 22 | 22 | 22 | 22 |
| 31TT | 31TT | 31TT | 31TT | 31TT |
| 31TP | 31TP | 31TP | 31TP | 31TP |
| 31-14F | 31-14F | 31-14F | 31-14F | 31-14F |
| 31-15F | 31-15F | 31-15F | 31-15F | 31-15F |
| 32-14F | 32-14F | 32-14F | 32-14F | 32-14F |
| 32-15F | 32-15F | 32-15F | 32-15F | 32-15F |

2C - 90° ELBOW THREADED

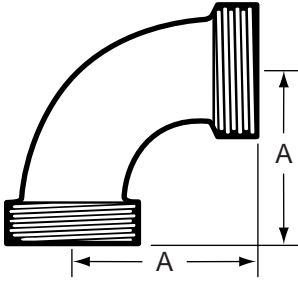

| Size Tube OD | A |
|-----------------|-------|
| 1 | 2.187 |
| 1 1/2 | 2.937 |
| 2 | 3.718 |
| 2 1/2 | 4.593 |
| 3 | 5.437 |
| 4 | 7.000 |

2E - 90° ELBOW BEVEL SEAT WITH 13H NUT

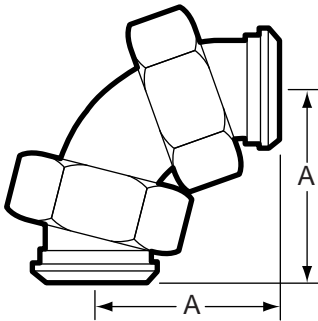

| Size Tube OD | A |
|-----------------|-------|
| 1 | 2.000 |
| 1 1/2 | 2.875 |
| 2 | 3.718 |
| 2 1/2 | 4.843 |
| 3 | 5.906 |
| 4 | 8.062 |

2F - 90° ELBOW THREADED X 13H NUT

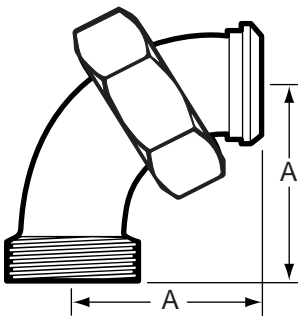

| Size Tube OD | A |
|-----------------|-------|
| 1 | 2.000 |
| 1 1/2 | 2.875 |
| 2 | 3.718 |
| 2 1/2 | 4.843 |
| 3 | 5.906 |
| 4 | 8.062 |

2K - 45° ELBOW THREADED

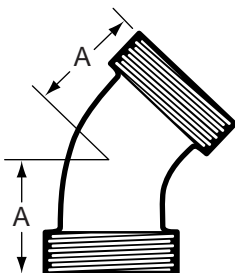

| Size Tube OD | A |
|-----------------|-------|
| 1 | 2.000 |
| 1 1/2 | 2.312 |
| 2 | 2.687 |
| 2 1/2 | 3.250 |
| 3 | 3.750 |
| 4 | 4.500 |

2P - 45° ELBOW 13H NUT X THREAD

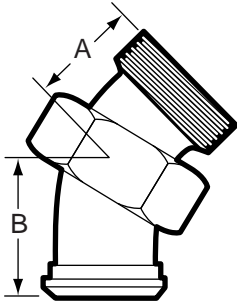

| Size Tube OD | A | B |
|-----------------|-------|-------|
| 1 | 1.312 | 2.000 |
| 1 1/2 | 1.625 | 2.437 |
| 2 | 1.937 | 2.750 |
| 2 1/2 | 2.375 | 3.312 |
| 3 | 2.812 | 3.625 |
| 4 | 3.500 | 4.250 |

7 - TEE ALL ENDS THREADED

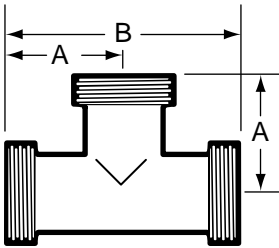

| Size Tube OD | A | B |
|-----------------|-------|-------|
| 1 | 1.812 | 3.625 |
| 1 1/2 | 2.375 | 4.750 |
| 2 | 2.781 | 5.437 |
| 2 1/2 | 3.187 | 6.375 |
| 3 | 3.500 | 7.000 |
| 4 | 4.656 | 9.312 |

7A - TEE THREADED X THREADED X 13H NUT

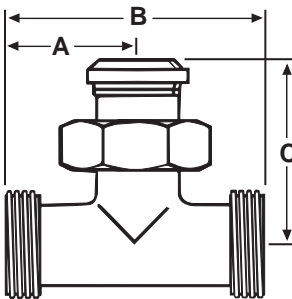

| Size Tube OD | A | B | C |
|-----------------|-------|-------|-------|
| 1 | 1.812 | 3.625 | 2.500 |
| 1 1/2 | 2.375 | 4.750 | 3.125 |
| 2 | 2.781 | 5.437 | 3.562 |
| 2 1/2 | 3.187 | 6.375 | 4.062 |
| 3 | 3.500 | 7.000 | 4.312 |
| 4 | 4.656 | 9.312 | 5.375 |

7B - TEE THREADED X 13H NUT X THREADED

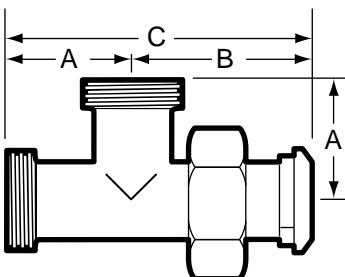

| Size Tube OD | A | B | C |
|-----------------|-------|-------|--------|
| 1 | 1.182 | 2.500 | 4.313 |
| 1 1/2 | 2.375 | 3.125 | 5.500 |
| 2 | 2.781 | 3.562 | 6.343 |
| 2 1/2 | 3.187 | 4.062 | 7.250 |
| 3 | 3.500 | 4.312 | 7.812 |
| 4 | 4.656 | 5.375 | 10.031 |

9 - CROSS THREADED

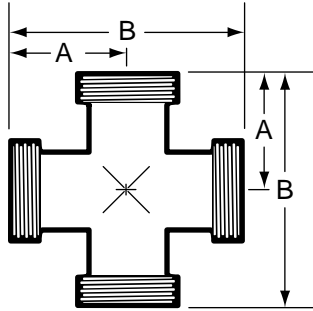

| Size Tube OD | A | B |
|-----------------|-------|-------|
| 1 | 1.812 | 3.625 |
| 1 1/2 | 2.375 | 4.750 |
| 2 | 2.781 | 5.437 |
| 2 1/2 | 3.187 | 6.375 |
| 3 | 3.500 | 7.000 |
| 4 | 4.656 | 9.312 |

13H - HEX UNION NUT

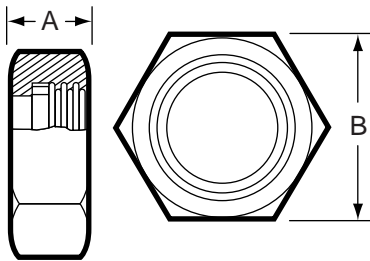

| Size Tube OD | A | B |
|-----------------|-------|-------|
| 1 | 0.906 | 1.812 |
| 1 1/2 | 0.968 | 2.406 |
| 2 | 1.062 | 3.000 |
| 2 1/2 | 1.187 | 3.593 |
| 3 | 1.281 | 4.187 |
| 4 | 1.500 | 5.437 |

14 - PLAIN RECESSED FERRULE (T316L Material Only)

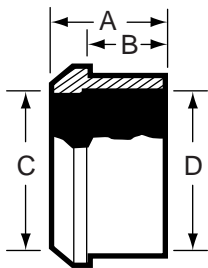

| Size Tube OD | A | B | C | D |
|-----------------|-------|-------|-------|-------|
| 1 | 0.750 | 0.500 | 0.870 | 1.000 |
| 1 1/2 | 0.875 | 0.625 | 1.370 | 1.500 |
| 2 | 0.968 | 0.687 | 1.870 | 2.000 |
| 2 1/2 | 1.062 | 0.750 | 2.370 | 2.500 |
| 3 | 1.125 | 0.812 | 2.870 | 3.000 |
| 4 | 1.250 | 0.812 | 3.834 | 4.000 |

14R - PLAIN RECESSLESS FERRULE (Expanding)

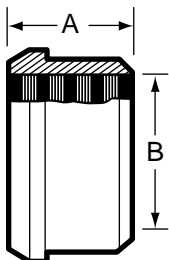

| Size Tube OD | A | B |
|-----------------|-------|-------|
| 1 | 0.750 | 1.000 |
| 1 1/2 | 1.125 | 1.500 |
| 2 | 1.312 | 2.000 |
| 2 1/2 | 1.375 | 2.500 |
| 3 | 1.437 | 3.000 |
| 4 | 1.500 | 4.000 |

14A - PLAIN WELDING FERRULE

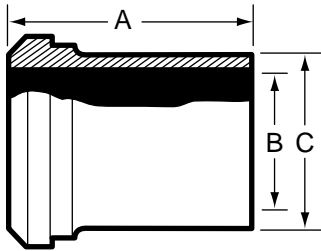

| Size Tube OD | A | B | C |
|-----------------|-------|-------|-------|
| 1 | 1.375 | 0.870 | 1.000 |
| 1 1/2 | 1.500 | 1.370 | 1.500 |
| 2 | 1.500 | 1.870 | 2.000 |
| 2 1/2 | 1.750 | 2.370 | 2.500 |
| 3 | 1.750 | 2.870 | 3.000 |
| 4 | 1.750 | 3.834 | 4.000 |

14PR - SHORT PLAIN WELDING FERRULE

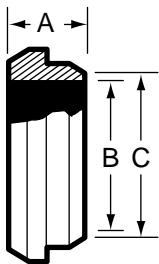

| Size Tube OD | A | B | C |
|-----------------|-------|-------|-------|
| 1 | 0.687 | 0.870 | 1.000 |
| 1 1/2 | 0.687 | 1.370 | 1.500 |
| 2 | 0.718 | 1.870 | 2.000 |
| 2 1/2 | 0.843 | 2.370 | 2.500 |
| 3 | 0.937 | 2.870 | 3.000 |
| 4 | 1.000 | 3.834 | 4.000 |

14W - TANK WELDING PLAIN FERRULE

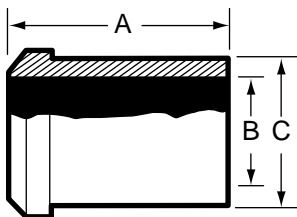

| Size Tube OD | A | B | C |
|-----------------|-------|-------|-------|
| 1 | 2.375 | 0.870 | 1.156 |
| 1 1/2 | 2.531 | 1.370 | 1.671 |
| 2 | 2.781 | 1.870 | 2.187 |
| 2 1/2 | 3.062 | 2.370 | 2.703 |
| 3 | 3.531 | 2.870 | 3.218 |
| 4 | 4.312 | 3.834 | 4.250 |

14WL - LONG PLAIN WELDING FERRULE

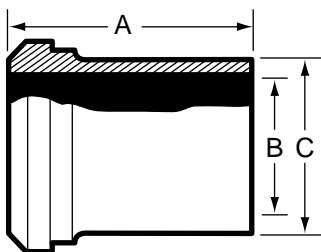

| Size Tube OD | A | B | C |
|-----------------|-------|-------|-------|
| 1 | 2.000 | 0.870 | 1.000 |
| 1 1/2 | 2.250 | 1.370 | 1.500 |
| 2 | 2.500 | 1.870 | 2.000 |
| 2 1/2 | 2.750 | 2.370 | 2.500 |
| 3 | 3.000 | 2.870 | 3.000 |
| 4 | 4.000 | 3.834 | 4.000 |

15 - THREADED RECESSED FERRULE (T316L Material Only)

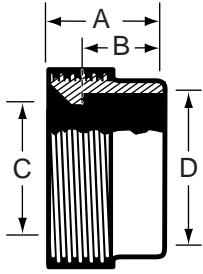

| Size Tube OD | A | B | C | D |
|-----------------|-------|-------|-------|-------|
| 1 | 1.187 | 0.500 | 0.870 | 1.000 |
| 1 1/2 | 0.875 | 0.625 | 1.370 | 1.500 |
| 2 | 1.031 | 0.687 | 1.870 | 2.000 |
| 2 1/2 | 1.125 | 0.750 | 2.370 | 2.500 |
| 3 | 1.250 | 0.812 | 2.870 | 3.000 |
| 4 | 1.375 | 0.937 | 3.834 | 4.000 |

15A - THREADED WELDING FERRULE

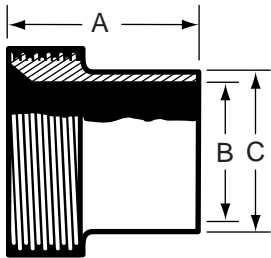

| Size Tube OD | A | B | C |
|-----------------|-------|-------|-------|
| 1 | 1.375 | 0.870 | 1.000 |
| 1 1/2 | 1.500 | 1.370 | 1.500 |
| 2 | 1.500 | 1.870 | 2.000 |
| 2 1/2 | 1.750 | 2.370 | 2.500 |
| 3 | 1.750 | 2.870 | 3.000 |
| 4 | 1.750 | 3.834 | 4.000 |

15R - THREADED RECESSLESS FERRULE (Expanding)

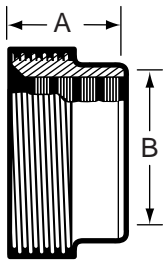

| Size Tube OD | A | B |
|-----------------|-------|-------|
| 1 | 0.812 | 1.000 |
| 1 1/2 | 1.125 | 1.500 |
| 2 | 1.375 | 2.000 |
| 2 1/2 | 1.500 | 2.500 |
| 3 | 1.625 | 3.000 |
| 4 | 1.625 | 4.000 |

15TR - SHORT THREADED WELDING FERRULE

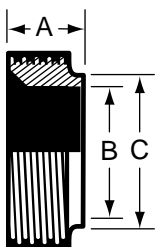

| Size Tube OD | A | B | C |
|-----------------|-------|-------|-------|
| 1 | 0.687 | 0.870 | 1.000 |
| 1 1/2 | 0.687 | 1.370 | 1.500 |
| 2 | 0.718 | 1.870 | 2.000 |
| 2 1/2 | 0.843 | 2.370 | 2.500 |
| 3 | 0.937 | 2.870 | 3.000 |
| 4 | 1.000 | 3.834 | 4.000 |

15W - TANK WELDING FERRULE

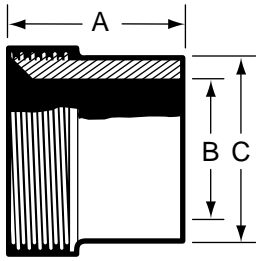

| Size Tube OD | A | B | C |
|-----------------|-------|-------|-------|
| 1 | 1.500 | 0.870 | 1.250 |
| 1 1/2 | 1.625 | 1.370 | 1.750 |
| 2 | 1.750 | 1.870 | 2.312 |
| 2 1/2 | 1.750 | 2.370 | 2.875 |
| 3 | 1.812 | 2.870 | 3.375 |
| 4 | 2.125 | 3.834 | 4.250 |

15WL - LONG WELDING FERRULE

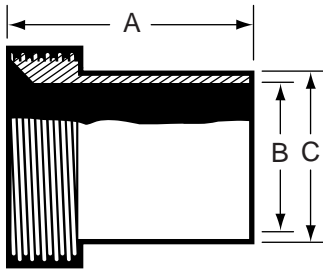

| Size Tube OD | A | B | C |
|-----------------|-------|-------|-------|
| 1 | 2.000 | 0.870 | 1.000 |
| 1 1/2 | 2.250 | 1.370 | 1.500 |
| 2 | 2.500 | 1.870 | 2.000 |
| 2 1/2 | 2.750 | 2.370 | 2.500 |
| 3 | 3.000 | 2.870 | 3.000 |
| 4 | 4.000 | 3.834 | 4.000 |

16A - PLAIN CAP



| Size Tube OD | A | B |
|-----------------|-------|-------|
| 1 | 1.312 | 0.468 |
| 1 1/2 | 1.843 | 0.562 |
| 2 | 2.375 | 0.625 |
| 2 1/2 | 2.906 | 0.656 |
| 3 | 3.437 | 0.718 |
| 4 | 4.500 | 0.812 |

23B - TAPPED THERMOMETER CAP

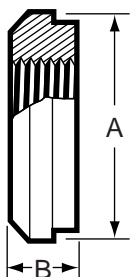

| Size Tube OD | A | B |
|-----------------|-------|-------|
| *1 | 1.312 | 0.468 |
| 1 1/2 | 1.843 | 0.562 |
| 2 | 2.375 | 0.625 |
| 2 1/2 | 2.906 | 0.656 |
| 3 | 3.437 | 0.718 |
| 4 | 4.500 | 0.812 |

*1" Standard 1/2" FNPT. All others 3/4".

14AHR - RUBBER HOSE ADAPTER

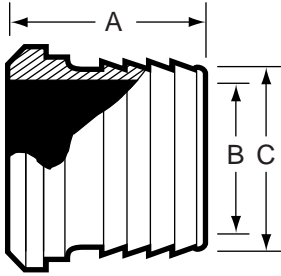

| Size Tube OD | A | B | C |
|-----------------|-------|-------|-------|
| 1 | 1.687 | 0.870 | 1.000 |
| 1 1/2 | 1.687 | 1.370 | 1.500 |
| 2 | 2.312 | 1.870 | 2.000 |
| 2 1/2 | 2.343 | 2.370 | 2.000 |
| 3 | 3.500 | 2.870 | 3.000 |
| 4 | 4.000 | 3.834 | 4.000 |

14AHT - TYGON HOSE ADAPTER

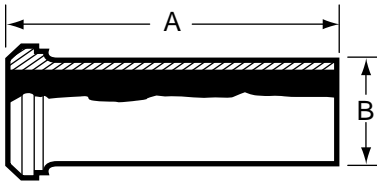

| Size Tube OD | A | B |
|-----------------|-------|-------|
| 1 | 4.687 | 1.000 |
| 1 1/2 | 4.718 | 1.500 |
| 2 | 4.718 | 2.000 |
| 2 1/2 | 4.843 | 2.500 |
| 3 | 4.906 | 3.000 |
| 4 | 5.218 | 4.000 |

15AHR - THREADED RUBBER HOSE ADAPTER

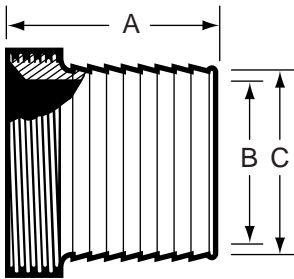

| Size Tube OD | A | B | C |
|-----------------|-------|-------|-------|
| 1 | 1.687 | 0.870 | 1.000 |
| 1 1/2 | 1.687 | 1.370 | 1.500 |
| 2 | 2.312 | 1.870 | 2.000 |
| 2 1/2 | 2.343 | 2.370 | 2.000 |
| 3 | 3.500 | 2.870 | 3.000 |
| 4 | 4.000 | 3.834 | 4.000 |

15AHT - THREADED TYGON HOSE ADAPTER

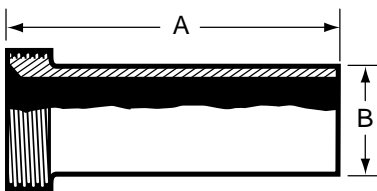

| Size Tube OD | A | B |
|-----------------|-------|-------|
| 1 | 4.687 | 1.000 |
| 1 1/2 | 4.718 | 1.500 |
| 2 | 4.718 | 2.000 |
| 2 1/2 | 4.843 | 2.500 |
| 3 | 4.906 | 3.000 |
| 4 | 5.218 | 4.000 |

14-22 - ADAPTER 13H NUT X FNPT

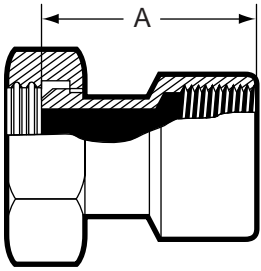

| Size Tube OD | A |
|-----------------|-------|
| 1 | 2.500 |
| 1 1/2 | 2.937 |
| 2 | 2.937 |
| 2 1/2 | 3.375 |
| 3 | 3.562 |
| 4 | 3.750 |

14-19 - ADAPTER 13H NUT X MNPT

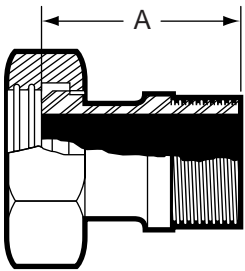

| Size Tube OD | A |
|-----------------|-------|
| 1 | 3.125 |
| 1 1/2 | 3.250 |
| 2 | 3.312 |
| 2 1/2 | 4.062 |
| 3 | 4.250 |
| 4 | 4.312 |

21 - ADAPTER ACME THREAD X MNPT

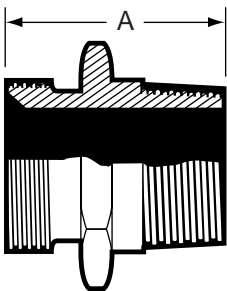

| Size Tube OD | A |
|-----------------|-------|
| 1 | 2.437 |
| 1 1/2 | 2.437 |
| 2 | 2.531 |
| 2 1/2 | 3.156 |
| 3 | 3.406 |
| 4 | 3.593 |

22 - ADAPTER ACME THREAD X FNPT

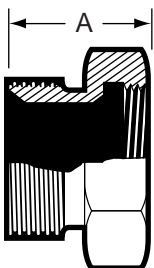

| Size Tube OD | A |
|-----------------|-------|
| 1 | 1.937 |
| 1 1/2 | 2.156 |
| 2 | 2.156 |
| 2 1/2 | 2.468 |
| 3 | 2.718 |
| 4 | 3.031 |

31-14F - CONCENTRIC REDUCER 13H X 13H

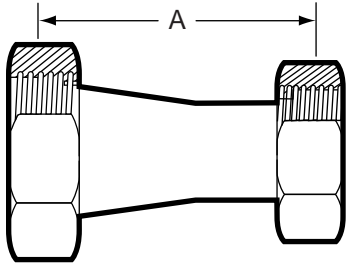

| Size Tube OD | A |
|-----------------|-------|
| 1 1/2 x 1 | 4.062 |
| 2 x 1 | 6.093 |
| 2 x 1 1/2 | 4.218 |
| 2 1/2 x 1 1/2 | 6.343 |
| 2 1/2 x 2 | 4.343 |
| 3 x 2 | 6.437 |
| 3 x 2 1/2 | 4.687 |
| 4 x 2 1/2 | 8.750 |
| 4 x 3 | 6.750 |

31-15F - CONCENTRIC REDUCER PLAIN BEVEL X THREAD

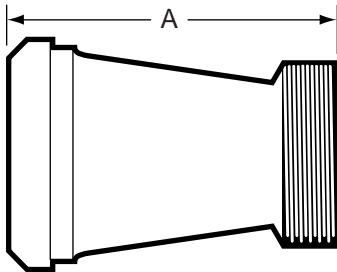

| Size Tube OD | A |
|-----------------|-------|
| *1 1/2 x 1 | 3.375 |
| 2 x 1 | 5.406 |
| 2 x 1 1/2 | 3.406 |
| 2 1/2 x 1 1/2 | 5.531 |
| 2 1/2 x 2 | 3.562 |
| 3 x 2 | 5.656 |
| 3 x 2 1/2 | 3.781 |
| 4 x 2 1/2 | 7.843 |
| 4 x 3 | 5.937 |

*Hex Nut included.

31TT - CONCENTRIC REDUCER THREAD X THREAD

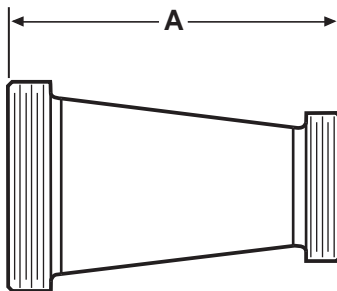

| Size Tube OD | A |
|-----------------|-------|
| 1 1/2 x 1 | 3.375 |
| 2 x 1 | 5.406 |
| 2 x 1 1/2 | 3.406 |
| 2 1/2 x 1 1/2 | 5.531 |
| 2 1/2 x 2 | 3.562 |
| 3 x 2 | 5.656 |
| 3 x 2 1/2 | 3.781 |
| 4 x 2 1/2 | 7.843 |
| 4 x 3 | 5.937 |

31TP - CONCENTRIC REDUCER THREAD X 13H NUT

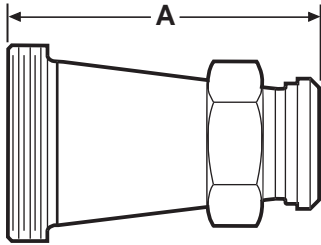

| Size Tube OD | A |
|-----------------|--------|
| 1 1/2 x 1 | 4.062 |
| 2 x 1 | 6.093 |
| 2 x 1 1/2 | 4.218 |
| 2 1/2 x 1 1/2 | 6.343 |
| 2 1/2 x 2 | 4.343 |
| 3 x 2 | 6.437 |
| 3 x 2 1/2 | 4.687 |
| 4 x 2 | 10.500 |
| 4 x 2 1/2 | 8.750 |
| 4 x 3 | 6.750 |

32-14F - ECCENTRIC REDUCER 13H NUT X 13H NUT

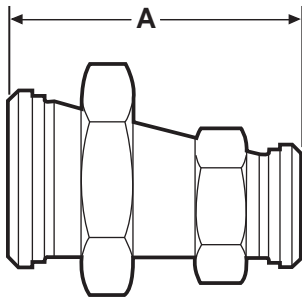

| Size Tube OD | A |
|-----------------|--------|
| 1 1/2 x 1 | 4.062 |
| 2 x 1 | 6.093 |
| 2 x 1 1/2 | 4.218 |
| 2 1/2 x 1 1/2 | 6.143 |
| 2 1/2 x 2 | 4.343 |
| 3 x 2 | 6.437 |
| 3 x 2 1/2 | 4.687 |
| 4 x 2 | 10.500 |
| 4 x 2 1/2 | 8.750 |
| 4 x 3 | 6.750 |

32-15F - ECCENTRIC REDUCER PLAIN BEVEL X THREAD

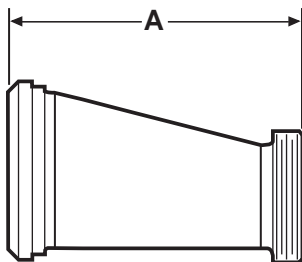

| Size Tube OD | A |
|-----------------|-------|
| *1 1/2 x 1 | 3.375 |
| 2 x 1 | 5.406 |
| 2 x 1 1/2 | 3.406 |
| 2 1/2 x 1 1/2 | 5.531 |
| 2 1/2 x 2 | 3.562 |
| 3 x 2 | 5.656 |
| 3 x 2 1/2 | 3.781 |
| 4 x 2 | 9.718 |
| 4 x 2 1/2 | 7.843 |
| 4 x 3 | 5.937 |

*Hex Nut included.

32TT - ECCENTRIC REDUCER THREAD X THREAD

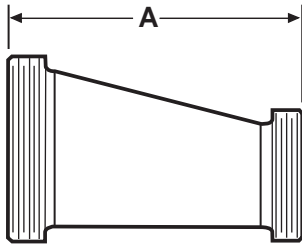

| Size Tube OD | A |
|-----------------|-------|
| 1 1/2 x 1 | 3.375 |
| 2 x 1 | 5.406 |
| 2 x 1 1/2 | 3.406 |
| 2 1/2 x 1 1/2 | 5.531 |
| 2 1/2 x 2 | 3.562 |
| 3 x 2 | 5.656 |
| 3 x 2 1/2 | 3.781 |
| 4 x 2 | 9.718 |
| 4 x 2 1/2 | 7.843 |
| 4 x 3 | 5.937 |

32TP - ECCENTRIC REDUCER THREAD X 13H NUT

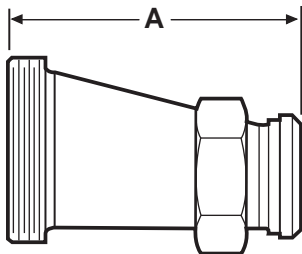

| Size Tube OD | A |
|-----------------|--------|
| 1 1/2 x 1 | 4.062 |
| 2 x 1 | 6.093 |
| 2 x 1 1/2 | 4.218 |
| 2 1/2 x 1 1/2 | 6.343 |
| 2 1/2 x 2 | 4.343 |
| 3 x 2 | 6.437 |
| 3 x 2 1/2 | 4.687 |
| 4 x 2 | 10.500 |
| 4 x 2 1/2 | 8.750 |
| 4 x 3 | 6.750 |

JOHN PERRY (T316L Material Only)

14PRJP - SHORT PLAIN WELDING FERRULE

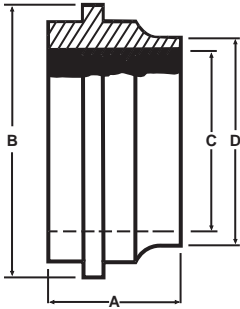

| Size Tube OD | A | B | C | D |
|-----------------|-------|-------|-------|-------|
| 1 | 0.643 | 1.316 | 0.870 | 1.000 |
| 1 1/2 | 0.643 | 1.848 | 1.370 | 1.500 |
| 2 | 0.710 | 2.380 | 1.870 | 2.000 |
| 2 1/2 | 0.807 | 2.912 | 2.370 | 2.500 |
| 3 | 0.807 | 3.444 | 2.870 | 3.000 |
| 4 | 1.009 | 4.508 | 3.834 | 4.000 |

15TRJP - SHORT THREAD WELDING FERRULE

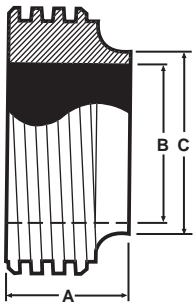

| Size Tube OD | A | B | C |
|-----------------|-------|-------|-------|
| 1 | 0.625 | 0.870 | 1.000 |
| 1 1/2 | 0.625 | 1.370 | 1.500 |
| 2 | 0.684 | 1.870 | 2.000 |
| 2 1/2 | 0.743 | 2.370 | 2.500 |
| 3 | 0.806 | 2.870 | 3.000 |
| 4 | 0.900 | 3.834 | 4.000 |

14AJP - LONG PLAIN WELDING FERRULE

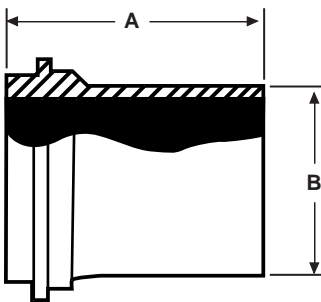

| Size Tube OD | A | B |
|-----------------|-------|-------|
| 1 | 1.375 | 1.000 |
| 1 1/2 | 1.500 | 1.500 |
| 2 | 1.500 | 2.000 |
| 2 1/2 | 1.750 | 2.500 |
| 3 | 1.750 | 3.000 |
| 4 | 1.750 | 4.000 |

JOHN PERRY (T316L Material Only)

15AJP - LONG THREAD WELDING FERRULE

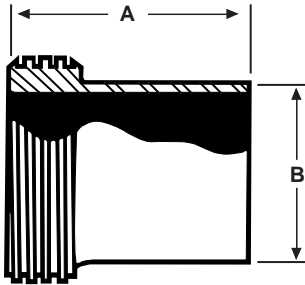

| Size Tube OD | A | B |
|-----------------|-------|-------|
| 1 | 1.375 | 1.000 |
| 1 1/2 | 1.500 | 1.500 |
| 2 | 1.500 | 2.000 |
| 2 1/2 | 1.750 | 2.500 |
| 3 | 1.750 | 3.000 |
| 4 | 1.750 | 4.000 |

16AJP - CAP

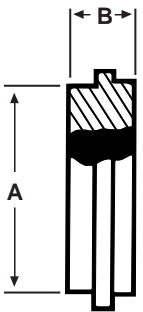

| Size Tube OD | A | B |
|-----------------|-------|-------|
| 1 | 1.125 | 0.468 |
| 1 1/2 | 1.656 | 0.500 |
| 2 | 2.187 | 0.531 |
| 2 1/2 | 2.656 | 0.594 |
| 3 | 3.187 | 0.625 |
| 4 | 4.187 | 0.625 |

FITTINGS



E-Line Fittings



E-LINE FITTINGS....

E-Line Fittings have a male and female interface construction to ensure rigidity of your system.

VNE offers E-Line Fittings in sizes 1" through 6" in T304 and T316L material. VNE offers Polished ID and OD Fittings for immediate shipment. Other polished combinations may be ordered.

Gaskets for E-Line Fittings are available in several different materials, Buna-N, EPDM, Teflon®, Silicone, and Viton.

E-LINE FITTING SPECIFICATIONS....

Size Range: 1" OD through 6" OD

Materials: T304
T316L

Finish: No. 7 - ID & OD
No. 5 - OD only
No. 3 - ID only
No. 1 - unpolished

ORDERING SPECIFICATIONS....

Specify:

- Quantity
- Product description or Part No.
- Size
- Material Type
- Polish Requirements

LIMITED WARRANTY....

VNE Corporation products are warranted to be free from defects in material and workmanship for a period of one year from the date of shipment. Any product that proves to be defective shall be repaired or replaced at the option of VNE, providing it has been used as recommended and in strict accordance with recognized piping practices, and that has not been subject to extraordinary service, such as encountered under severe corrosive or abrasive conditions.

VNE makes no warranties, express or implied, other than those listed above.

VNE shall not be liable for any consequential, indirect, incidental or contingent damages.

VNE CORPORATION

P.O. Box 1698 • 1149 Barberry Drive • Janesville, WI 53547

TEL: 608-756-4930 • FAX: 608-756-3643 • 1-800-356-1111 • Web site: vnestainless.com

E-LINE TYPE

| VNE | ROBERT JAMES | ANDRON | WAUKESHA | G & H |
|--------------|---------------|------------|-------------|------------|
| EC21 | RJ2CZ | ---- | 2CI | HDI-2C |
| E2FI | RJ2FZ | ---- | 2FI | HDI-2F |
| E2EI | ---- | ---- | 2EI | HDI-2E |
| E2KI | RJ2KZ | ---- | 2KI | HDI-2K |
| E2PI | RJ2PZ | ---- | 2PI | HDI-2P |
| E7I | RJ7Z | ---- | 7I | HDI-7 |
| E7AI | RJ7AZ | ---- | 7AI | ---- |
| E7EI | RJ7EZ | ---- | 7EI | ---- |
| E7BI | RJ7BZ | ---- | 7BI | ---- |
| E9I | RJ9Z | ---- | 9I | ---- |
| E13IS | RJ13ZS | ---- | 13IS | HDI-13-UD |
| E13IU | RJ13Z | ---- | 13IU | HDI-13-U |
| E14WI | RJ14WZ | AY14WI | 14WI | 14WH |
| E15WI | RJ15WZ | AY15WI | 15WI | 15WH |
| E14WLI | RJ14WLZ | AY14WLI | 14WLI | 14WLH |
| E15WLI | RJ15WLZ | AY15WLI | 15WLI | 15WLH |
| E14HRI | RJ14HRZ | AY14AHR | 14HRI | ---- |
| E14HTI | RJ14HTZ | AY14AHT | 14HTI | ---- |
| E15HRI | RJ15HRZ | AY15AHR | 15HRI | ---- |
| E15HTI | RJ15HTZ | AY15AHT | 15HTI | ---- |
| E17-14I-15I | RJ17-14Z-15Z | ---- | 17-14I-15I | ---- |
| E17-15I-15I | RJ17-15Z-15Z | ---- | 17-15I-15I | ---- |
| E17-14I-14I | RJ17-14Z-14Z | ---- | 17-14I-14I | ---- |
| E17-14I-14 | RJ17-14Z-14 | ---- | 17-14I-14 | ---- |
| E17-14I-14MP | RJ17-14Z-14MP | ---- | 17-14I-14MP | ---- |
| E17-14I-15 | RJ17-14Z-15 | ---- | 17-14I-15 | ---- |
| E17-15I-14 | RJ17-15Z-14 | ---- | 17-15I-14 | ---- |
| E17-15I-15 | RJ17-15Z-15 | ---- | 17-15I-15I | ---- |
| E17-15I-14MP | RJ17-15Z-14MP | ---- | 17-15I-14MP | ---- |
| E21I-14I | RJ21-14Z | ---- | 21FI-14I | ---- |
| E21I-15I | RJ21-15Z | ---- | 21F1-15I | ---- |
| E22I-14I | RJ22-14Z | ---- | 22FI-14I | ---- |
| E22I-15I | RJ22-15Z | ---- | 22FI-15I | ---- |
| E16AI-14I | RJ16AZ-14Z | AY16AI-14I | 16AI-14I | HDI-16A-14 |
| E16AI-15I | RJ16AZ-15Z | AY16AI-15I | 16AI-15I | HDI-16A-15 |
| E31I-14I | RJ31Z-14Z | ---- | 31I-14FI | HDI-31-14F |
| E31I-15I | RJ31Z-15Z | ---- | 31I-15FI | HDI-31-15F |
| E31I-15I-14I | RJ31Z-15Z-14Z | ---- | ---- | ---- |
| E31I-15I-15I | RJ31Z-15Z-15Z | ---- | ---- | ---- |
| E32I-14I | RJ32Z-14Z | ---- | 32I-14FI | HDI-32-14F |
| E32I-15I | RJ32Z-15Z | ---- | 32I-15FI | HDI-32-15F |

E2CI - 90° ELBOW FEMALE X FEMALE

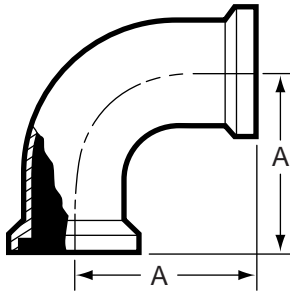

| Size Tube OD | A |
|-----------------|--------|
| 1 | 2.281 |
| 1 1/2 | 3.182 |
| 2 | 4.031 |
| 2 1/2 | 4.906 |
| 3 | 5.718 |
| 4 | 7.343 |
| 6 | 10.125 |

E2FI - 90° ELBOW MALE X FEMALE

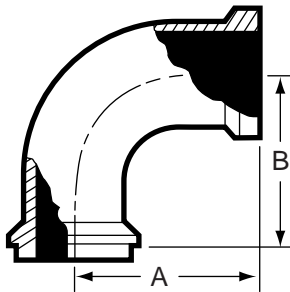

| Size Tube OD | A | B |
|-----------------|--------|-------|
| 1 | 2.281 | 2.093 |
| 1 1/2 | 3.187 | 3.000 |
| 2 | 4.031 | 3.781 |
| 2 1/2 | 4.906 | 4.593 |
| 3 | 5.718 | 5.406 |
| 4 | 7.343 | 7.031 |
| 6 | 10.125 | 9.187 |

E2EI - 90° ELBOW MALE X MALE

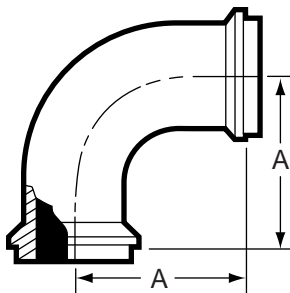

| Size Tube OD | A |
|-----------------|-------|
| 1 | 2.093 |
| 1 1/2 | 3.000 |
| 2 | 3.781 |
| 2 1/2 | 4.593 |
| 3 | 5.406 |
| 4 | 7.031 |
| 6 | 9.187 |

E2KI - 45° ELBOW FEMALE X FEMALE

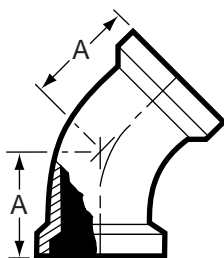

| Size Tube OD | A |
|-----------------|-------|
| 1 | 1.406 |
| 1 1/2 | 1.875 |
| 2 | 2.281 |
| 2 1/2 | 2.718 |
| 3 | 3.093 |
| 4 | 3.843 |
| 6 | 4.875 |

E2PI - 45° ELBOW FEMALE X MALE

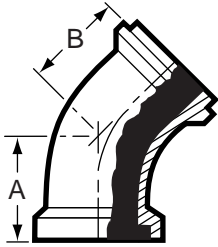

| Size Tube OD | A | B |
|-----------------|-------|-------|
| 1 | 1.406 | 1.218 |
| 1 1/2 | 1.875 | 1.687 |
| 2 | 2.281 | 2.031 |
| 2 1/2 | 2.718 | 2.406 |
| 3 | 3.093 | 2.781 |
| 4 | 3.843 | 3.531 |
| 6 | 4.875 | 4.562 |

E2HI - 45° ELBOW MALE X MALE

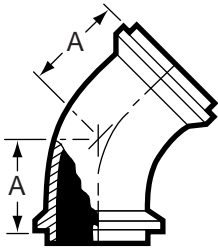

| Size Tube OD | A |
|-----------------|-------|
| 1 | 1.218 |
| 1 1/2 | 1.687 |
| 2 | 2.031 |
| 2 1/2 | 2.406 |
| 3 | 2.781 |
| 4 | 3.531 |
| 6 | 4.562 |

E7I - TEE ALL ENDS FEMALE

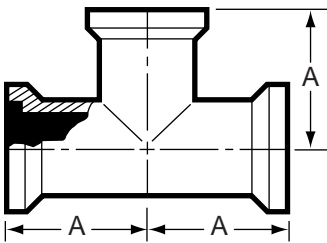

| Size Tube OD | A |
|-----------------|-------|
| 1 | 1.875 |
| 1 1/2 | 2.593 |
| 2 | 3.062 |
| 2 1/2 | 3.468 |
| 3 | 3.812 |
| 4 | 4.968 |
| 6 | 6.750 |

E7AI - TEE FEMALE X FEMALE X MALE

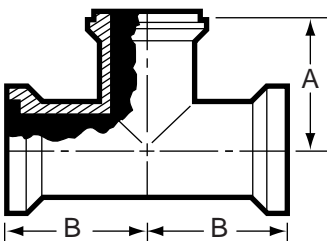

| Size Tube OD | A | B |
|-----------------|-------|-------|
| 1 | 1.687 | 1.875 |
| 1 1/2 | 2.406 | 2.593 |
| 2 | 2.812 | 3.062 |
| 2 1/2 | 3.156 | 3.468 |
| 3 | 3.500 | 3.812 |
| 4 | 4.656 | 4.968 |
| 6 | 6.437 | 6.750 |

E7BI - TEE MALE X FEMALE X FEMALE

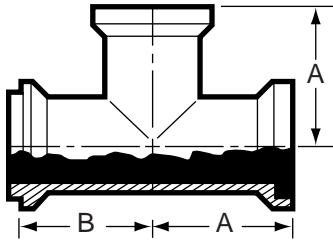

| Size Tube OD | A | B |
|-----------------|-------|-------|
| 1 | 1.875 | 1.687 |
| 1 1/2 | 2.593 | 2.406 |
| 2 | 3.062 | 2.812 |
| 2 1/2 | 3.468 | 3.156 |
| 3 | 3.812 | 3.500 |
| 4 | 4.968 | 4.656 |
| 6 | 6.750 | 6.437 |

E7EI - TEE MALE X MALE X FEMALE

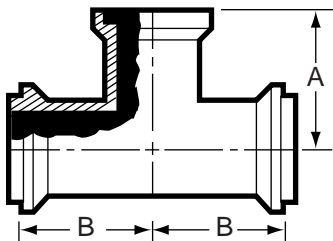

| Size Tube OD | A | B |
|-----------------|-------|-------|
| 1 | 1.875 | 1.687 |
| 1 1/2 | 2.593 | 2.406 |
| 2 | 3.062 | 2.812 |
| 2 1/2 | 3.468 | 3.156 |
| 3 | 3.812 | 3.500 |
| 4 | 4.968 | 4.656 |
| 6 | 6.750 | 6.437 |

E7HI - TEE ALL ENDS MALE

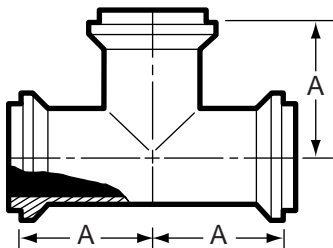

| Size Tube OD | A |
|-----------------|-------|
| 1 | 1.687 |
| 1 1/2 | 2.406 |
| 2 | 2.812 |
| 2 1/2 | 3.156 |
| 3 | 3.500 |
| 4 | 4.656 |
| 6 | 6.437 |

E7RI - REDUCING TEE ALL ENDS FEMALE

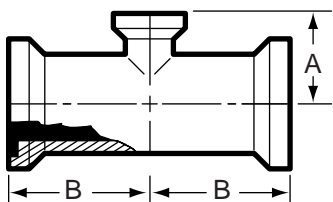

| Size Tube OD | A | B |
|-----------------|--------------|-------|
| 1 1/2 x 1 | 2.156 | 2.593 |
| 2 x 1 | 3.093 | 4.031 |
| 2 x 1 1/2 | 2.718 | 3.062 |
| 2 1/2 x 1 1/2 | 4.156 | 4.000 |
| 2 1/2 x 2 | 3.312 | 3.500 |
| 3 x 2 | 3.562 | 3.812 |
| 3 x 2 1/2 | 3.750 | 3.812 |
| 4 x 2 | 5.031 | 5.218 |
| 4 x 2 1/2 | 4.906 | 5.218 |
| 4 x 3 | 4 3/84 29/32 | 5.218 |
| 6 x 3 | 6.843 | 6.750 |
| 6 x 4 | 6.968 | 6.750 |

E9I - CROSS ALL ENDS FEMALE

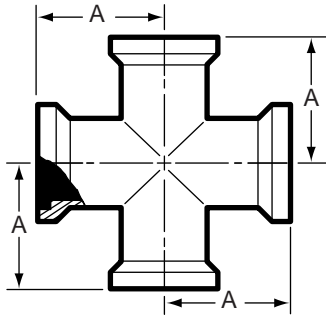

| Size Tube OD | A |
|-----------------|-------|
| 1 | 1.875 |
| 1 1/2 | 2.593 |
| 2 | 3.062 |
| 2 1/2 | 3.468 |
| 3 | 3.812 |
| 4 | 4.968 |
| 6 | 6.750 |

E14WI - SHORT MALE WELDING FERRULE

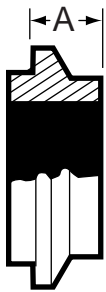

| Size Tube OD | A |
|-----------------|-------|
| 1 | 0.593 |
| 1 1/2 | 0.750 |
| 2 | 0.781 |
| 2 1/2 | 0.843 |
| 3 | 0.906 |
| 4 | 1.031 |
| 6 | 0.812 |

E14WLI - LONG MALE WELDING FERRULE

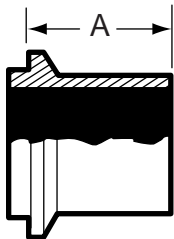

| Size Tube OD | A |
|-----------------|-------|
| 1 | 1.563 |
| 1 1/2 | 1.843 |
| 2 | 2.062 |
| 2 1/2 | 2.187 |
| 3 | 2.375 |
| 4 | 2.687 |
| 6 | 3.812 |

E15WI - SHORT FEMALE WELDING FERRULE



| Size Tube OD | A |
|-----------------|-------|
| 1 | 0.781 |
| 1 1/2 | 0.937 |
| 2 | 1.031 |
| 2 1/2 | 1.156 |
| 3 | 1.218 |
| 4 | 1.343 |
| 6 | 1.125 |

E15WLI - LONG FEMALE WELDING FERRULE

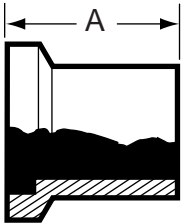

| Size Tube OD | A |
|-----------------|-------|
| 1 | 1.750 |
| 1 1/2 | 2.031 |
| 2 | 2.312 |
| 2 1/2 | 2.500 |
| 3 | 2.687 |
| 4 | 3 |
| 6 | 4 |

E14HRI - MALE RUBBER HOSE ADAPTER

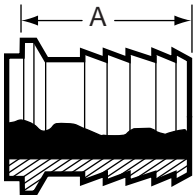

| Size Tube OD | A |
|-----------------|-------|
| 1 | 3.562 |
| 1 1/2 | 3.750 |
| 2 | 3.750 |
| 2 1/2 | 3.812 |
| 3 | 3.875 |
| 4 | 4.062 |
| 6 | 8.812 |

E14HTI - MALE TYGON HOSE ADAPTER

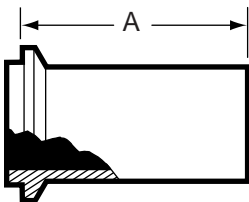

| Size Tube OD | A |
|-----------------|-------|
| 1 | 4.062 |
| 1 1/2 | 4.281 |
| 2 | 4.500 |
| 2 1/2 | 4.812 |
| 3 | 5.062 |
| 4 | 5.187 |

E15HRI - FEMALE RUBBER HOSE ADAPTER

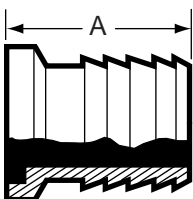

| Size Tube OD | A |
|-----------------|-------|
| 1 | 3.750 |
| 1 1/2 | 3.937 |
| 2 | 4.062 |
| 2 1/2 | 4.125 |
| 3 | 4.187 |
| 4 | 4.375 |
| 6 | 9.125 |

E15HTI - FEMALE TYGON HOSE ADAPTER

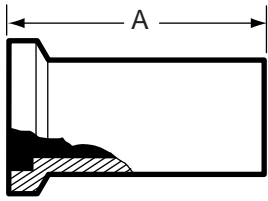

| Size Tube OD | A |
|-----------------|-------|
| 1 | 4.250 |
| 1 1/2 | 4.468 |
| 2 | 4.750 |
| 2 1/2 | 5.125 |
| 3 | 5.375 |
| 4 | 5.500 |

E14WHI - MALE WELD FERRULE

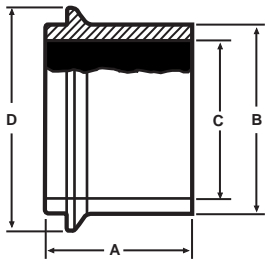

| Size Tube OD | A | B | C | D |
|-----------------|-------|-------|-------|-------|
| 1 | 1.625 | 1.160 | 0.870 | 2.000 |
| 1 1/2 | 1.625 | 1.687 | 1.370 | 2.008 |
| 2 | 1.750 | 2.250 | 1.870 | 2.648 |
| 2 1/2 | 1.750 | 2.708 | 2.370 | 3.317 |
| 3 | 1.812 | 3.313 | 2.870 | 3.868 |
| 4 | 2.125 | 4.250 | 3.834 | 4.882 |

E15WHI - FEMALE WELD FERRULE

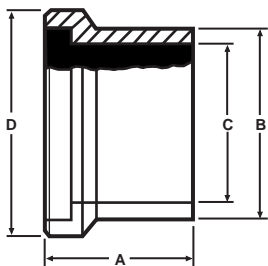

| Size Tube OD | A | B | C | D |
|-----------------|-------|-------|-------|-------|
| 1 | 1.625 | 1.160 | 0.870 | 2.000 |
| 1 1/2 | 1.625 | 1.687 | 1.370 | 2.008 |
| 2 | 1.750 | 2.250 | 1.870 | 2.648 |
| 2 1/2 | 1.750 | 2.708 | 2.370 | 3.317 |
| 3 | 1.812 | 3.313 | 2.870 | 3.868 |
| 4 | 2.125 | 4.250 | 3.834 | 4.882 |

E17-14I-14I - ADAPTER BOTH ENDS MALE

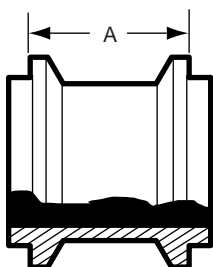

| Size Tube OD | A |
|-----------------|-------|
| 1 | 1.187 |
| 1 1/2 | 1.500 |
| 2 | 1.562 |
| 2 1/2 | 1.687 |
| 3 | 1.812 |
| 4 | 2.062 |
| 6 | 1.625 |

E17-14I-15I - ADAPTER MALE X FEMALE

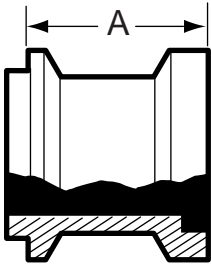

| Size Tube OD | A |
|-----------------|-------|
| 1 | 1.375 |
| 1 1/2 | 1.687 |
| 2 | 1.812 |
| 2 1/2 | 1.937 |
| 3 | 2.125 |
| 4 | 2.375 |
| 6 | 1.937 |

E17-15I-15I - ADAPTER BOTH ENDS FEMALE

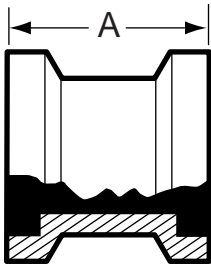

| Size Tube OD | A |
|-----------------|-------|
| 1 | 1.562 |
| 1 1/2 | 1.875 |
| 2 | 2.062 |
| 2 1/2 | 2.312 |
| 3 | 2.437 |
| 4 | 2.687 |
| 6 | 2.250 |

E17-14I-14-ADAPTER MALE X 13H NUT

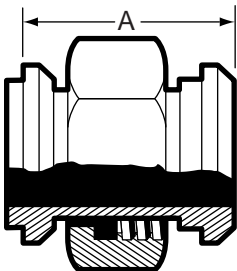

| Size Tube OD | A |
|-----------------|-------|
| 1 | 1.968 |
| 1 1/2 | 2.250 |
| 2 | 2.250 |
| 2 1/2 | 2.562 |
| 3 | 2.687 |
| 4 | 2.812 |

E17-14I-14MP - ADAPTER MALE X CLAMP

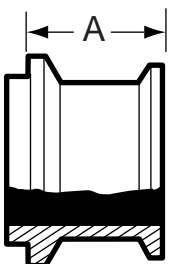

| Size Tube OD | A |
|-----------------|-------|
| 1 | 1.093 |
| 1 1/2 | 1.250 |
| 2 | 1.250 |
| 2 1/2 | 1.312 |
| 3 | 1.406 |
| 4 | 1.656 |
| 6 | 1.687 |

E17-14I-15 - ADAPTER MALE X ACME THREAD

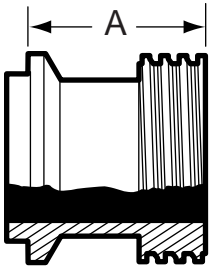

| Size Tube OD | A |
|-----------------|-------|
| 1 | 1.031 |
| 1 1/2 | 1.468 |
| 2 | 1.500 |
| 2 1/2 | 1.687 |
| 3 | 1.812 |
| 4 | 2.062 |

E17-15I-14 - ADAPTER FEMALE X 13H NUT

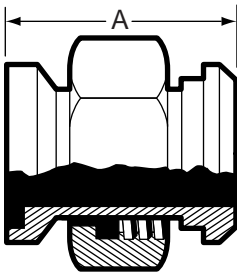

| Size Tube OD | A |
|-----------------|-------|
| 1 | 2.156 |
| 1 1/2 | 2.437 |
| 2 | 2.500 |
| 2 1/2 | 2.875 |
| 3 | 3.000 |
| 4 | 3.093 |

E17-15I-14MP - ADAPTER FEMALE X CLAMP

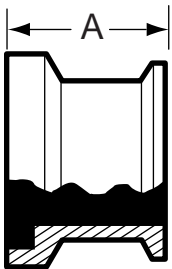

| Size Tube OD | A |
|-----------------|-------|
| 1 | 1.281 |
| 1 1/2 | 1.437 |
| 2 | 1.500 |
| 2 1/2 | 1.625 |
| 3 | 1.718 |
| 4 | 1.968 |
| 6 | 2.000 |

E17-15I-15 - ADAPTER FEMALE X ACME THREAD

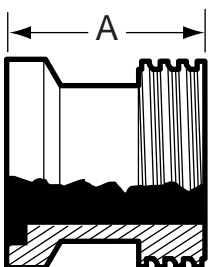

| Size Tube OD | A |
|-----------------|-------|
| 1 | 1.562 |
| 1 1/2 | 1.656 |
| 2 | 1.750 |
| 2 1/2 | 2.000 |
| 3 | 2.125 |
| 4 | 2.375 |

E21I-14I - ADAPTER MALE X MNPT

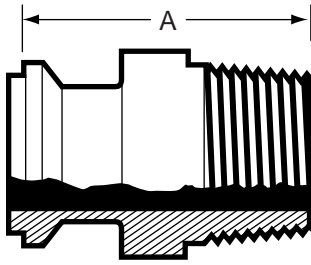

| Size Tube OD | A |
|-----------------|-------|
| 1 | 2.343 |
| 1 1/2 | 2.500 |
| 2 | 2.593 |
| 2 1/2 | 3.125 |
| 3 | 3.406 |
| 4 | 3.593 |
| 6 | 4.812 |

E21I-15I - ADAPTER FEMALE X MNPT

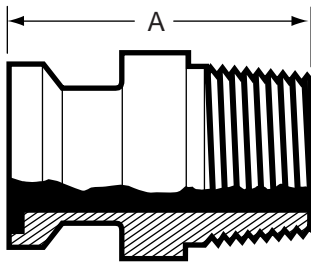

| Size Tube OD | A |
|-----------------|-------|
| 1 | 2.531 |
| 1 1/2 | 2.687 |
| 2 | 2.843 |
| 2 1/2 | 3.437 |
| 3 | 3.718 |
| 4 | 3.906 |
| 6 | 5.125 |

E22I-14I - ADAPTER MALE X FNPT

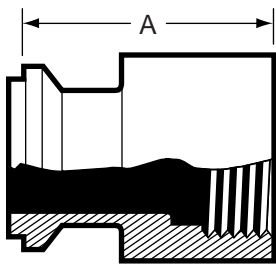

| Size Tube OD | A |
|-----------------|-------|
| 1 | 1.687 |
| 1 1/2 | 2.187 |
| 2 | 2.218 |
| 2 1/2 | 2.437 |
| 3 | 2.718 |
| 4 | 3.031 |

E22I-15I - ADAPTER FEMALE X FNPT

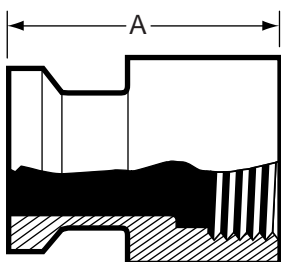

| Size Tube OD | A |
|-----------------|-------|
| 1 | 1.906 |
| 1 1/2 | 2.375 |
| 2 | 2.468 |
| 2 1/2 | 2.781 |
| 3 | 3.031 |
| 4 | 3.343 |

E23BI - THERMOMETER CAP

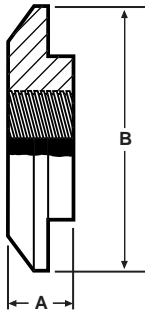

| Size Tube OD | A | B |
|-----------------|-------|-------|
| *1 | 0.500 | 2.000 |
| 1 1/2 | 0.500 | 2.000 |
| 2 | 0.562 | 2.625 |
| 2 1/2 | 0.750 | 3.312 |
| 3 | 0.750 | 3.875 |
| 4 | 0.750 | 4.875 |

*STD 1/2" FNPT. All others 3/4" FNPT.

E28AI - LATERAL ALL ENDS FEMALE

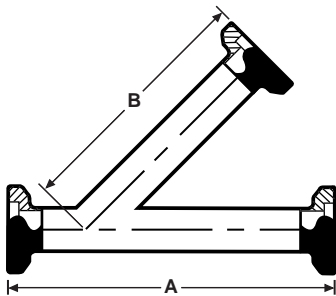

| Size Tube OD | A | B |
|-----------------|--------|--------|
| 1 | 7.562 | 5.781 |
| 1 1/2 | 9.250 | 7.125 |
| 2 | 10.687 | 8.156 |
| 2 1/2 | 12.437 | 9.656 |
| 3 | 13.187 | 10.093 |
| 4 | 15.500 | 12.093 |
| 6 | 19.125 | 15.625 |

E28BI - TRUE Y ALL ENDS FEMALE

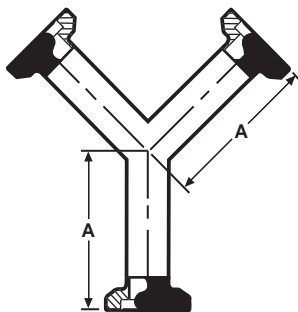

| Size Tube OD | A |
|-----------------|-------|
| 1 | 3.781 |
| 1 1/2 | 3.937 |
| 2 | 5.031 |
| 2 1/2 | 6.156 |
| 3 | 7.218 |
| 4 | 9.343 |
| 6 | 9.125 |

E16AI-14I - MALE END CAP



| Size Tube OD | A | B |
|-----------------|-------|-------|
| 1 | 2.000 | 0.500 |
| 1 1/2 | 2.000 | 0.500 |
| 2 | 2.625 | 0.562 |
| 2 1/2 | 3.312 | 0.750 |
| 3 | 3.875 | 0.750 |
| 4 | 4.875 | 0.750 |
| 6 | 7.500 | 0.875 |

E16AI-15I - FEMALE END CAP



| Size Tube OD | A | B |
|-----------------|-------|-------|
| 1 | 2.000 | 0.500 |
| 1 1/2 | 2.000 | 0.500 |
| 2 | 2.625 | 0.687 |
| 2 1/2 | 3.312 | 0.750 |
| 3 | 3.875 | 0.750 |
| 4 | 4.875 | 0.750 |
| 6 | 7.500 | 0.750 |

GASKETS



| Gasket Materials | Part Number |
|------------------|----------------|
| Buna N | E40IH |
| EPDM | E40IE |
| Teflon | E40IT |
| Viton® | E40IV |
| Silicone | E40IS |

Available in 1" to 6" sizes.

E13IU - BOLTED CLAMP

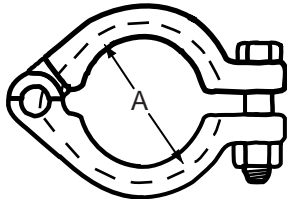

| Size Tube OD | A |
|-----------------|-------|
| 1 | 2.122 |
| 1 1/2 | 2.122 |
| 2 | 2.800 |
| 2 1/2 | 3.500 |
| 3 | 4.060 |
| 4 | 5.000 |
| 6 | 7.625 |

E13IS - HEAVY DUTY CLAMP

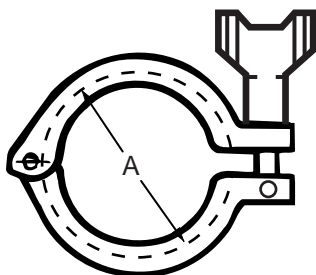

| Size Tube OD | A |
|-----------------|-------|
| 1 | 2.122 |
| 1 1/2 | 2.122 |
| 2 | 2.800 |
| 2 1/2 | 3.500 |
| 3 | 4.060 |
| 4 | 5.000 |
| 6 | 7.625 |

***PSI SERVICE RATINGS FOR SANITARY STAINLESS STEEL CLAMPS**

| Size Tube OD | E13IU | | E13IS | |
|--------------|-------|--------|-------|--------|
| | @70°F | @250°F | @70°F | @250°F |
| 1" & 1 1/2" | 500 | 250 | 500 | 250 |
| 2" | 450 | 250 | 450 | 250 |
| 2 1/2" | 400 | 200 | 400 | 200 |
| 3" | 350 | 150 | 350 | 150 |
| 4" | 200 | 125 | 200 | 125 |
| 6" | 150 | 75 | 150 | 75 |

*Service ratings are based upon hydrostatic tests using Standard Molded Buna-N gasket material with proper expansion of ferules, joint assembly, and the absence of shock pressure. All ratings systems are dependent upon related components in the system and proper installation.

E31-14I - CONCENTRIC REDUCER MALE X MALE

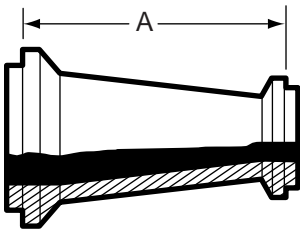

| Size Tube OD | A |
|---------------|-------|
| 1 1/2 x 1 | 3.343 |
| 2 x 1 | 5.375 |
| 2 x 1 1/2 | 3.500 |
| 2 1/2 x 1 1/2 | 5.593 |
| 2 1/2 x 2 | 3.562 |
| 3 x 1 1/2 | 7.656 |
| 3 x 2 | 5.625 |
| 3 x 2 1/2 | 3.750 |
| 4 x 2 | 9.812 |
| 4 x 2 1/2 | 7.875 |
| 4 x 3 | 5.937 |
| 6 x 3 | 7.218 |
| 6 x 4 | 7.343 |

E31-14I-15I - CONCENTRIC REDUCER MALE X FEMALE

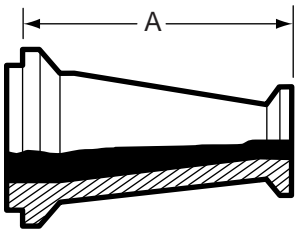

| Size Tube OD | A |
|---------------|--------|
| 1 1/2 x 1 | 3.531 |
| 2 x 1 | 5.562 |
| 2 x 1 1/2 | 3.718 |
| 2 1/2 x 1 1/2 | 5.781 |
| 2 1/2 x 2 | 4.875 |
| 3 x 1 1/2 | 7.843 |
| 3 x 2 | 5.937 |
| 3 x 2 1/2 | 4.062 |
| 4 x 2 | 10.062 |
| 4 x 2 1/2 | 8.187 |
| 4 x 3 | 6.250 |
| 6 x 3 | 7.406 |
| 6 x 4 | 7.875 |

E31-15I-14I - CONCENTRIC REDUCER FEMALE X MALE

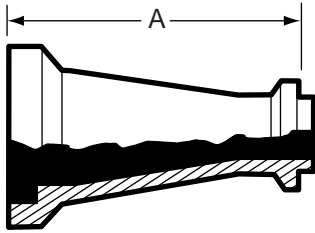

| Size Tube OD | A |
|-----------------|--------|
| 1 1/2 x 1 | 3.531 |
| 2 x 1 | 5.625 |
| 2 x 1 1/2 | 3.781 |
| 2 1/2 x 1 1/2 | 5.906 |
| 2 1/2 x 2 | 3.937 |
| 3 x 1 1/2 | 7.968 |
| 3 x 2 | 6.000 |
| 3 x 2 1/2 | 4.062 |
| 4 x 2 | 10.125 |
| 4 x 2 1/2 | 8.187 |
| 4 x 3 | 6.250 |
| 6 x 3 | 7.531 |
| 6 x 4 | 7.656 |

E31-15I - CONCENTRIC REDUCER BOTH ENDS FEMALE

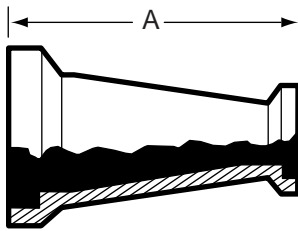

| Size Tube OD | A |
|-----------------|--------|
| 1 1/2 x 1 | 3.718 |
| 2 x 1 | 5.812 |
| 2 x 1 1/2 | 3.968 |
| 2 1/2 x 1 1/2 | 6.093 |
| 2 1/2 x 2 | 4.187 |
| 3 x 1 1/2 | 8.156 |
| 3 x 2 | 6.250 |
| 3 x 2 1/2 | 4.375 |
| 4 x 2 | 10.375 |
| 4 x 2 1/2 | 8.500 |
| 4 x 3 | 6.562 |
| 6 x 3 | 7.843 |
| 6 x 4 | 7.968 |

E32I-14I - ECCENTRIC REDUCER MALE X MALE

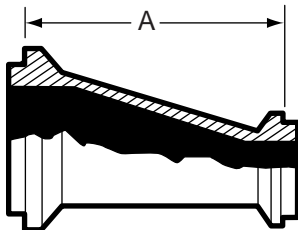

| Size Tube OD | A |
|-----------------|-------|
| 1 1/2 x 1 | 3.343 |
| 2 x 1 | 5.375 |
| 2 x 1 1/2 | 3.500 |
| 2 1/2 x 1 1/2 | 5.593 |
| 2 1/2 x 2 | 3.562 |
| 3 x 1 1/2 | 7.656 |
| 3 x 2 | 5.625 |
| 3 x 2 1/2 | 3.750 |
| 4 x 2 | 9.812 |
| 4 x 2 1/2 | 7.875 |
| 4 x 3 | 5.937 |
| 6 x 3 | 7.218 |
| 6 x 4 | 7.968 |

E32I-14I-15I - ECCENTRIC REDUCER MALE X FEMALE

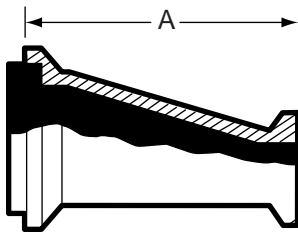

| Size Tube OD | A |
|-----------------|--------|
| 1 1/2 x 1 | 3.531 |
| 2 x 1 | 5.562 |
| 2 x 1 1/2 | 3.718 |
| 2 1/2 x 1 1/2 | 5.781 |
| 2 1/2 x 2 | 4.875 |
| 3 x 1 1/2 | 7.843 |
| 3 x 2 | 5.937 |
| 3 x 2 1/2 | 4.062 |
| 4 x 2 | 10.062 |
| 4 x 2 1/2 | 8.187 |
| 4 x 3 | 6.250 |
| 6 x 3 | 7.406 |
| 6 x 4 | 7.875 |

E32I-15I-14I - ECCENTRIC REDUCER FEMALE X MALE

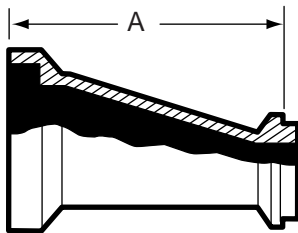

| Size Tube OD | A |
|-----------------|--------|
| 1 1/2 x 1 | 3.531 |
| 2 x 1 | 5.625 |
| 2 x 1 1/2 | 3.781 |
| 2 1/2 x 1 1/2 | 5.906 |
| 2 1/2 x 2 | 3.937 |
| 3 x 1 1/2 | 7.968 |
| 3 x 2 | 6.000 |
| 3 x 2 1/2 | 4.062 |
| 4 x 2 | 10.125 |
| 4 x 2 1/2 | 8.187 |
| 4 x 3 | 6.250 |
| 6 x 3 | 7.531 |
| 6 x 4 | 7.656 |

E32I-15I - ECCENTRIC REDUCER BOTH ENDS FEMALE

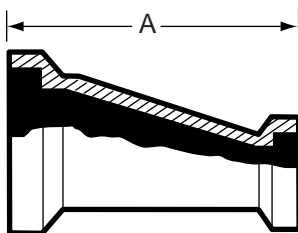

| Size Tube OD | A |
|-----------------|--------|
| 1 1/2 x 1 | 3.718 |
| 2 x 1 | 5.812 |
| 2 x 1 1/2 | 3.968 |
| 2 1/2 x 1 1/2 | 6.093 |
| 2 1/2 x 2 | 4.187 |
| 3 x 1 1/2 | 8.156 |
| 3 x 2 | 6.250 |
| 3 x 2 1/2 | 4.375 |
| 4 x 2 | 10.375 |
| 4 x 2 1/2 | 8.500 |
| 4 x 3 | 6.585 |
| 6 x 3 | 7.687 |
| 6 x 4 | 8.000 |

SCHEDULE 5 - (T316L)

E14WI-5 - SHORT MALE WELDING FERRULE

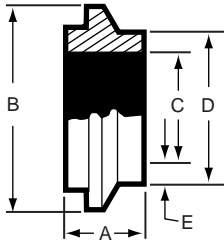

| Size Pipe | A | B | C | D | E |
|-----------|-------|-------|-------|-------|-------|
| 1 | 0.945 | 2.000 | 1.185 | 1.315 | 0.065 |
| 1 1/2 | 1.024 | 2.648 | 1.770 | 1.900 | 0.065 |
| 2 | 1.142 | 3.317 | 2.245 | 2.375 | 0.065 |
| 2 1/2 | 1.220 | 3.868 | 2.709 | 2.875 | 0.083 |
| 3 | 1.343 | 4.882 | 3.334 | 3.500 | 0.083 |
| 4 | 1.343 | 5.882 | 4.334 | 4.500 | 0.083 |

E15WI-5 - SHORT FEMALE WELDING FERRULE

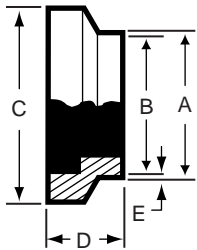

| Size Pipe | A | B | C | D | E |
|-----------|-------|-------|-------|-------|-------|
| 1 | 1.315 | 1.185 | 2.000 | 0.945 | 0.065 |
| 1 1/2 | 1.900 | 1.770 | 2.648 | 1.024 | 0.065 |
| 2 | 2.375 | 2.245 | 3.317 | 1.142 | 0.065 |
| 2 1/2 | 2.875 | 2.709 | 3.868 | 1.220 | 0.083 |
| 3 | 3.500 | 3.334 | 4.882 | 1.343 | 0.083 |
| 4 | 4.500 | 4.334 | 5.882 | 1.343 | 0.083 |

E16AI-14I-5 - MALE END CAP

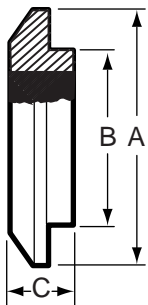

| Size Pipe | A | B | C |
|-----------|-------|-------|-------|
| 1 | 2.000 | 1.751 | 0.500 |
| 1 1/2 | 2.648 | 2.244 | 0.585 |
| 2 | 3.317 | 2.746 | 0.750 |
| 2 1/2 | 3.868 | 3.307 | 0.750 |
| 3 | 4.882 | 4.295 | 0.750 |
| 4 | 5.882 | 5.295 | 0.750 |

E16AI-15I-5 - FEMALE END CAP

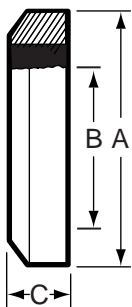

| Size Pipe | A | B | C |
|-----------|-------|-------|-------|
| 1 | 2.000 | 1.772 | 0.500 |
| 1 1/2 | 2.684 | 2.264 | 0.687 |
| 2 | 3.317 | 2.766 | 0.750 |
| 2 1/2 | 3.868 | 3.327 | 0.750 |
| 3 | 4.882 | 4.311 | 0.750 |
| 4 | 5.882 | 5.311 | 0.750 |

SCHEDULE 5 - (T316L)

E14WLI-5 - LONG MALE WELDING FERRULE

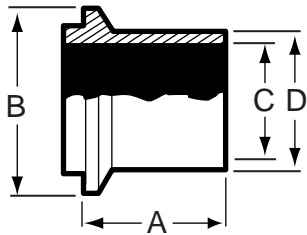

| Size Pipe | A | B | C | D |
|-----------|-------|-------|-------|-------|
| 1 | 1.562 | 2.000 | 1.185 | 1.315 |
| 1 1/2 | 1.843 | 2.648 | 1.770 | 1.900 |
| 2 | 2.062 | 3.317 | 2.245 | 2.375 |
| 2 1/2 | 1.562 | 3.868 | 2.709 | 2.875 |
| 3 | 1.562 | 4.882 | 3.334 | 3.500 |
| 4 | 1.562 | 5.882 | 4.334 | 4.500 |

E15WLI-5 - LONG FEMALE WELDING FERRULE

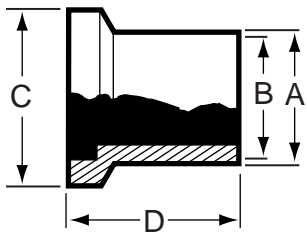

| Size Pipe | A | B | C | D |
|-----------|-------|-------|-------|-------|
| 1 | 1.315 | 1.185 | 2.000 | 1.750 |
| 1 1/2 | 1.900 | 1.770 | 2.648 | 2.031 |
| 2 | 2.375 | 2.245 | 3.317 | 2.312 |
| 2 1/2 | 2.875 | 2.370 | 3.868 | 2.500 |
| 3 | 3.500 | 2.870 | 4.882 | 2.687 |
| 4 | 4.500 | 3.834 | 5.882 | 3.000 |

E13IS-5 - HEAVY DUTY CLAMP - T304

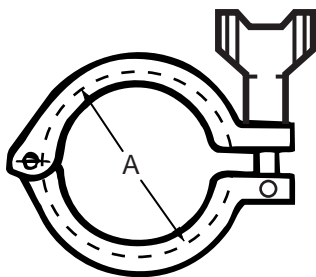

| Size Pipe | A |
|-----------|-------|
| 1 | 2.122 |
| 1 1/2 | 2.800 |
| 2 | 3.500 |
| 2 1/2 | 4.060 |
| 3 | 5.000 |
| 4 | 6.130 |

E13IU-5 - CLAMP BOLTED - T304

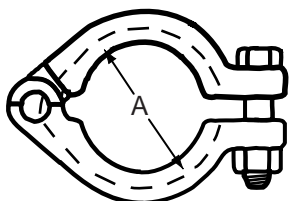

| Size Pipe | A |
|-----------|-------|
| 1 | 2.122 |
| 1 1/2 | 2.800 |
| 2 | 3.500 |
| 2 1/2 | 4.060 |
| 3 | 5.000 |
| 4 | 6.130 |

EQ - LINE

E14WQ-6L (T316L Material Only)

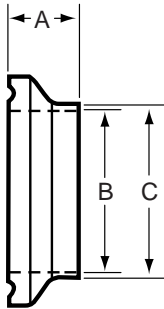

| Size Tube OD | A | B | C |
|-----------------|-------|-------|-------|
| 1 | 0.531 | 0.870 | 1.000 |
| 1 1/2 | 0.563 | 1.370 | 1.500 |
| 2 | 0.813 | 1.870 | 2.000 |
| 2 1/2 | 0.938 | 2.370 | 2.500 |
| 3 | 0.938 | 2.870 | 3.000 |
| 4 | 1.000 | 3.834 | 4.000 |

E16AQ-14Q

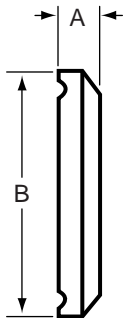

| Size Tube OD | A | B |
|-----------------|-------|-------|
| 1 | 0.313 | 2.000 |
| 1 1/2 | 0.313 | 2.000 |
| 2 | 0.438 | 2.648 |
| 2 1/2 | 0.500 | 3.313 |
| 3 | 0.500 | 3.870 |
| 4 | 0.625 | 4.870 |

FITTINGS



**Unpolished
Tube OD Fittings**



UNPOLISHED TUBE OD FITTINGS....

Unpolished Tube OD Weld Fittings are used in a wide variety of industrial applications where sanitary finishes are not generally required. VNE's tumbled finish presents a consistent uniform appearance.

VNE's Unpolished Weld Fittings are offered in nominal tube sizes 1/2" through 8" in T304 and T316L materials. Uniform wall thickness for 1/2" through 3" sizes measure .065 (16 ga). In 4" size, wall thickness measure .083 (14 ga), 6" and 8" .109 (12 ga).

TUBE OD FITTING SPECIFICATIONS....

Size Range: 1/2" OD through 8" OD

Materials: T304
T316L

Finish: Unpolished - Tumbled

ORDERING SPECIFICATIONS....

- Specify:**
- Quantity
 - Product description or Part No.
 - Size
 - Material Type
 - Polish Requirements

LIMITED WARRANTY....

VNE Corporation products are warranted to be free from defects in material and workmanship for a period of one year from the date of shipment. Any product that proves to be defective shall be repaired or replaced at the option of VNE, providing it has been used as recommended and in strict accordance with recognized piping practices, and that has not been subject to extraordinary service, such as encountered under severe corrosive or abrasive conditions.

VNE makes no warranties, express or implied, other than those listed above.

VNE shall not be liable for any consequential, indirect, incidental or contingent damages.

VNE CORPORATION

P.O. Box 1698 • 1149 Barberry Drive • Janesville, WI 53547

TEL: 608-756-4930 • FAX: 608-756-3643 • 1-800-356-1111 • Web site: vnestainless.com

V2WC - 90° ELBOW LESS TANGENTS

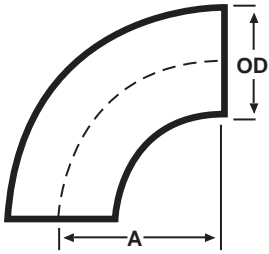

| Size Tube OD | A | Nom. Wall |
|-----------------|--------|-----------|
| 1/2 | 0.750 | 0.065 |
| 3/4 | 1.125 | 0.065 |
| 1 | 1.500 | 0.065 |
| 1 1/4 | 1.875 | 0.065 |
| 1 1/2 | 2.250 | 0.065 |
| 2 | 3.000 | 0.065 |
| 2 1/2 | 3.750 | 0.065 |
| 3 | 4.500 | 0.065 |
| 4 | 6.000 | 0.083 |
| 6 | 9.000 | 0.109 |
| 8 | 12.000 | 0.109 |

V2S - 90° ELBOW WITH TANGENTS

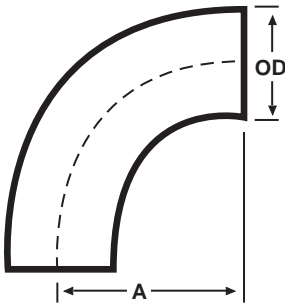

| Size Tube OD | A | Nom. Wall |
|-----------------|-------|-----------|
| 1 | 2.062 | 0.065 |
| 1 1/2 | 2.937 | 0.065 |
| 2 | 4.062 | 0.065 |
| 2 1/2 | 5.187 | 0.065 |
| 3 | 6.312 | 0.065 |
| 4 | 8.312 | 0.083 |

V2WU - 180° U BEND

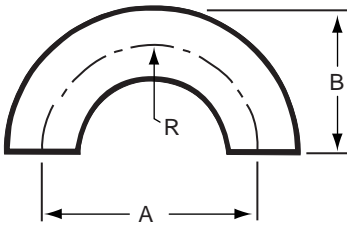

| Size Tube OD | A | B | C | R | Nom. Wall |
|-----------------|--------|--------|-------|-------|-----------|
| 1/2 | 1.500 | 1.000 | 0.500 | 0.750 | 0.065 |
| 3/4 | 2.250 | 1.500 | 0.750 | 1.125 | 0.065 |
| 1 | 3.000 | 2.000 | 1.000 | 1.500 | 0.065 |
| 1 1/4 | 3.750 | 2.500 | 1.250 | 1.875 | 0.065 |
| 1 1/2 | 4.500 | 3.000 | 1.500 | 2.250 | 0.065 |
| 2 | 6.000 | 4.000 | 2.000 | 3.000 | 0.065 |
| 2 1/2 | 7.500 | 5.000 | 2.500 | 3.750 | 0.065 |
| 3 | 9.000 | 6.000 | 3.000 | 4.500 | 0.065 |
| 4 | 12.000 | 8.000 | 4.000 | 6.000 | 0.083 |
| 6 | 18.000 | 12.000 | 6.000 | 9.000 | 0.109 |

UNPOLISHED TUBE OD FITTINGS

STAINLESS STEEL FITTINGS
PRODUCT CATALOG

V2WK - 45° ELBOW LESS TANGENTS

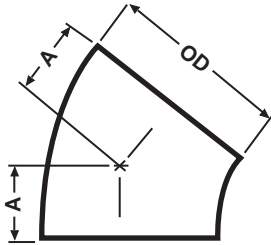

| Size Tube OD | A | Nom. Wall |
|-----------------|-------|-----------|
| 1/2 | 0.312 | 0.065 |
| 3/4 | 0.468 | 0.065 |
| 1 | 0.625 | 0.065 |
| 1 1/4 | 0.781 | 0.065 |
| 1 1/2 | 0.937 | 0.065 |
| 2 | 1.250 | 0.065 |
| 2 1/2 | 1.562 | 0.065 |
| 3 | 1.875 | 0.065 |
| 4 | 2.500 | 0.083 |
| 6 | 3.750 | 0.109 |
| 8 | 5.000 | 0.109 |

V2KS - 45° ELBOW WITH TANGENTS

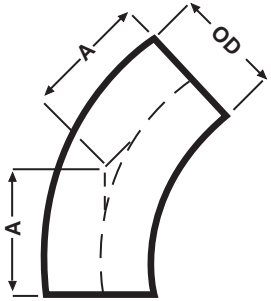

| Size Tube OD | A | Nom. Wall |
|-----------------|-------|-----------|
| 1 | 1.187 | 0.065 |
| 1 1/2 | 1.625 | 0.065 |
| 2 | 2.312 | 0.065 |
| 2 1/2 | 3.000 | 0.065 |
| 3 | 3.687 | 0.065 |
| 4 | 4.812 | 0.083 |

V7W - LONG TEE

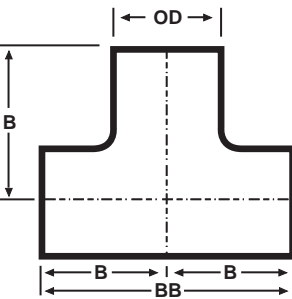

| Size Tube OD | B | BB | Nom. Wall |
|-----------------|-------------|--------|-----------|
| 1/2 | CONTACT VNE | | |
| 3/4 | CONTACT VNE | | |
| 1 | 1.875 | 3.750 | 0.065 |
| 1 1/2 | 2.250 | 4.500 | 0.065 |
| 1 1/4 | 2.250 | 4.500 | 0.065 |
| 2 | 3.000 | 6.000 | 0.065 |
| 2 1/2 | 3.000 | 6.000 | 0.065 |
| 3 | 3.250 | 6.500 | 0.065 |
| 4 | 3.875 | 7.750 | 0.083 |
| 6 | 5.625 | 11.250 | 0.109 |
| 8 | 7.000 | 14.000 | 0.109 |

V7WWW - SHORT TEE

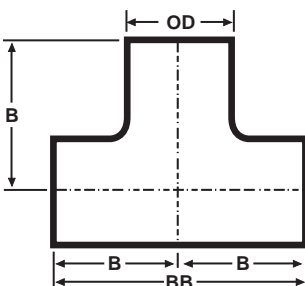

| Size Tube OD | B | BB | Nom. Wall |
|-----------------|-------|-------|-----------|
| 1 | 1.125 | 2.250 | 0.065 |
| 1 1/2 | 1.656 | 3.312 | 0.065 |
| 2 | 2.062 | 4.125 | 0.065 |
| 2 1/2 | 2.343 | 4.687 | 0.065 |
| 3 | 2.593 | 5.187 | 0.065 |
| 4 | 3.625 | 7.250 | 0.083 |

UNPOLISHED TUBE OD FITTINGS

STAINLESS STEEL FITTINGS
PRODUCT CATALOG

V7WR - REDUCING TEE

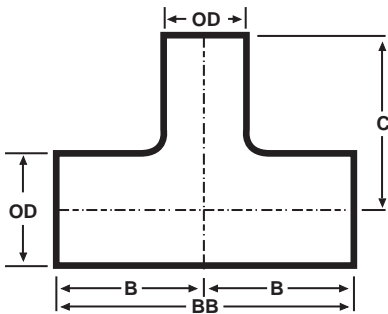

| Size Tube OD | BB | C | B | Nom. Wall |
|-----------------|-------------|-------|-------|-----------|
| 3/4 x 1/2 | CONTACT VNE | | | 0.065 |
| 1 x 1/2 | | | | 0.065 |
| 1 x 3/4 | | | | 0.065 |
| 1 1/2 x 1/2 | | | | 0.065 |
| 1 1/2 x 3/4 | | | | 0.065 |
| 1 1/2 x 1 | 4.500 | 2.125 | 2.250 | 0.065 |
| 1 1/2 x 1 1/4 | 4.500 | 2.250 | 2.250 | 0.065 |
| 2 x 1 | 6.000 | 2.375 | 3.000 | 0.065 |
| 2 x 1 1/4 | 6.000 | 2.500 | 3.000 | 0.065 |
| 2 x 1 1/2 | 6.000 | 2.500 | 3.000 | 0.065 |
| 2 1/2 x 1 1/2 | 6.000 | 3.250 | 3.000 | 0.065 |
| 2 1/2 x 2 | 6.000 | 3.250 | 3.000 | 0.065 |
| 3 x 1 1/2 | 6.500 | 3.000 | 3.250 | 0.065 |
| 3 x 2 | 6.500 | 3.500 | 3.250 | 0.065 |
| 3 x 2 1/2 | 6.500 | 3.250 | 3.250 | 0.065 |
| 4 x 2 | 7.750 | 4.000 | 3.875 | 0.083 |
| 4 x 2 1/2 | 7.750 | 3.750 | 3.875 | 0.083 |
| 4 x 3 | 7.750 | 3.750 | 3.875 | 0.083 |
| 6 x 2 | 11.250 | 5.625 | 5.625 | 0.109 |
| 6 x 3 | 11.250 | 5.625 | 5.625 | 0.109 |
| 6 x 4 | 11.250 | 5.625 | 5.625 | 0.109 |

V9W - CROSS

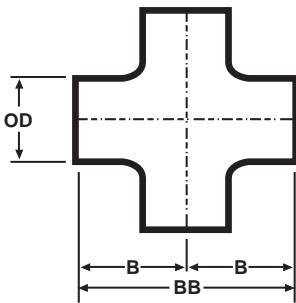

| Size Tube OD | B | BB | Nom. Wall |
|-----------------|-------------|--------|-----------|
| 1/2 | CONTACT VNE | | 0.065 |
| 3/4 | | | 0.065 |
| 1 | 1.875 | 3.750 | 0.065 |
| 1 1/2 | 2.250 | 4.500 | 0.065 |
| 1 1/4 | 2.250 | 4.500 | 0.065 |
| 2 | 3.000 | 6.000 | 0.065 |
| 2 1/2 | 3.000 | 6.000 | 0.065 |
| 3 | 3.250 | 6.500 | 0.065 |
| 4 | 3.875 | 7.750 | 0.083 |
| 6 | 5.625 | 11.250 | 0.109 |

V14WA - TYPE A STUB END WITH GROOVES

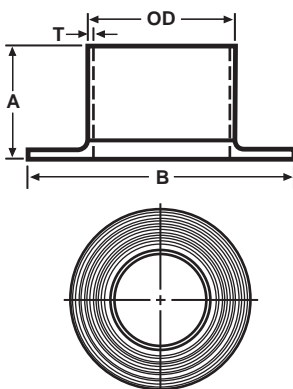

| Size Tube OD | A | B | Nom. Wall (T) |
|-----------------|-------|-------|--------------------|
| 1/2 | 1.375 | 1.625 | 0.065 |
| 3/4 | 1.375 | 1.687 | 0.065 |
| 1 | 1.625 | 2.000 | 0.065 |
| 1 1/4 | 1.375 | 2.500 | 0.065 |
| 1 1/2 | 1.750 | 2.875 | 0.065 |
| 2 | 1.500 | 3.625 | 0.065 |
| 2 1/2 | 2.000 | 4.125 | 0.065 |
| 3 | 2.250 | 5.000 | 0.065 |
| 4 | 2.625 | 6.187 | 0.083 |
| 6 | 3.000 | 8.500 | 0.109 |

UNPOLISHED TUBE OD FITTINGS

STAINLESS STEEL FITTINGS
PRODUCT CATALOG

F14WA - TYPE B STUB END LESS GROOVES

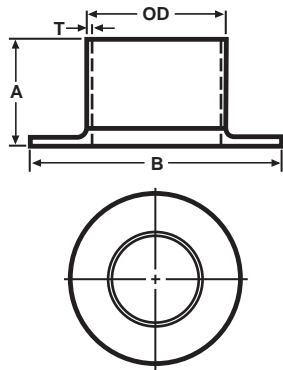

| Size Tube OD | A | B | Nom. Wall (T) |
|-----------------|-------|-------|--------------------|
| 1/2 | 1.375 | 1.625 | 0.065 |
| 3/4 | 1.375 | 1.687 | 0.065 |
| 1 | 1.625 | 2.000 | 0.065 |
| 1 1/4 | 1.625 | 2.500 | 0.065 |
| 1 1/2 | 1.750 | 2.875 | 0.065 |
| 2 | 1.500 | 3.625 | 0.065 |
| 2 1/2 | 2.000 | 4.125 | 0.065 |
| 3 | 2.250 | 5.000 | 0.065 |
| 4 | 2.625 | 6.187 | 0.083 |
| 6 | 3.000 | 8.500 | 0.109 |

V16W - WELD CAP

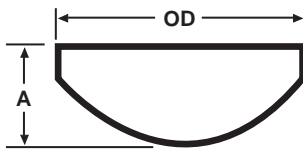

| Size Tube OD | A | Nom. Wall |
|-----------------|-------|-----------|
| 1/2 | 0.250 | 0.065 |
| 3/4 | 0.312 | 0.065 |
| 1 | 0.375 | 0.065 |
| 1 1/4 | 0.500 | 0.065 |
| 1 1/2 | 0.562 | 0.065 |
| 2 | 0.750 | 0.065 |
| 2 1/2 | 1.000 | 0.065 |
| 3 | 1.250 | 0.065 |
| 4 | 1.500 | 0.083 |
| 6 | 2.625 | 0.109 |
| 8 | 2.750 | 0.109 |

19WB - MALE NPT X WELD ADAPTER

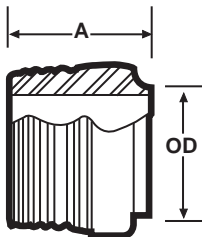

| Size Tube OD | A | Nom. Wall |
|-----------------|-------|-----------|
| 1/2 | 1.625 | 0.065 |
| 3/4 | 1.625 | 0.065 |
| 1 | 1.750 | 0.065 |
| 1 1/4 | 1.750 | 0.065 |
| 1 1/2 | 1.750 | 0.065 |
| 2 | 1.812 | 0.065 |
| 2 1/2 | 2.312 | 0.065 |
| 3 | 2.500 | 0.065 |
| 4 | 2.562 | 0.083 |
| 6 | 4.000 | 0.109 |

22WB - FEMALE NPT X WELD ADAPTER

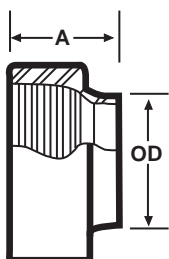

| Size Tube OD | A | Nom. Wall |
|-----------------|-------|-----------|
| 1/2 | 1.125 | 0.065 |
| 3/4 | 1.125 | 0.065 |
| 1 | 1.125 | 0.065 |
| 1 1/4 | 1.375 | 0.065 |
| 1 1/2 | 1.437 | 0.065 |
| 2 | 1.437 | 0.065 |
| 2 1/2 | 1.625 | 0.065 |
| 3 | 1.812 | 0.065 |
| 4 | 2.000 | 0.083 |

UNPOLISHED TUBE OD FITTINGS

V28WA - 45° LATERAL

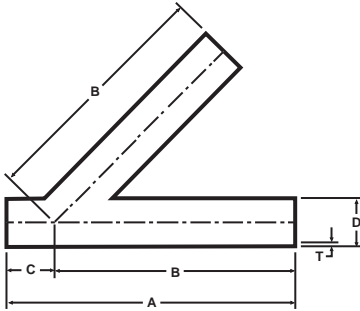

| Size Tube OD | A | B | C | D | Nom. Wall (T) |
|-----------------|--------|--------|-------|-------|------------------|
| 1 | 6.000 | 5.000 | 1.000 | 1.000 | 0.065 |
| 1 1/2 | 7.375 | 6.187 | 1.187 | 1.500 | 0.065 |
| 2 | 8.625 | 7.125 | 1.500 | 2.000 | 0.065 |
| 2 1/2 | 10.125 | 8.500 | 1.625 | 2.500 | 0.065 |
| 3 | 10.750 | 8.875 | 1.875 | 3.000 | 0.065 |
| 4 | 12.812 | 10.750 | 2.062 | 4.000 | 0.083 |
| 6 | 18.000 | 14.500 | 3.500 | 6.000 | 0.109 |

V28WB - TRUE Y

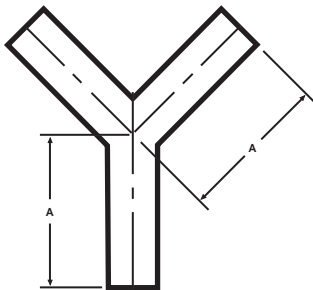

| Size Tube OD | A |
|-----------------|-------|
| 1 | 3.000 |
| 1 1/2 | 3.000 |
| 2 | 4.000 |
| 2 1/2 | 5.000 |
| 3 | 6.000 |
| 4 | 8.000 |
| 6 | 8.000 |

V31W - CONCENTRIC REDUCER

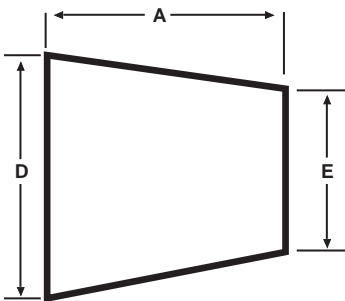

| Size Tube OD D x E | A | Nom. Wall |
|-----------------------|-------|---------------|
| 3/4 x 1/2 | * | 0.065 |
| 1 x 1/2 | * | 0.065 |
| 1 x 3/4 | * | 0.065 |
| 1 1/2 x 1/2 | * | 0.065 |
| 1 1/2 x 3/4 | * | 0.065 |
| 1 1/2 x 1 | 2.000 | 0.065 |
| 1 1/2 x 1 1/4 | 1.000 | 0.065 |
| 2 x 1 | 4.000 | 0.065 |
| 2 x 1 1/4 | 3.000 | 0.065 |
| 2 x 1 1/2 | 2.000 | 0.065 |
| 2 1/2 x 1 1/2 | 4.000 | 0.065 |
| 2 1/2 x 2 | 2.000 | 0.065 |
| 3 x 1 1/2 | 6.000 | 0.065 |
| 3 x 2 | 4.000 | 0.065 |
| 3 x 2 1/2 | 2.000 | 0.065 |
| 4 x 2 | 8.000 | 0.083 x 0.065 |
| 4 x 2 1/2 | 6.000 | 0.083 x 0.065 |
| 4 x 3 | 4.000 | 0.083 x 0.065 |
| 6 x 3 | 5.500 | 0.109 x 0.083 |
| 6 x 4 | 5.500 | 0.109 x 0.083 |

* Contact Factory for Exact Dimensions.

V32W - ECCENTRIC REDUCER

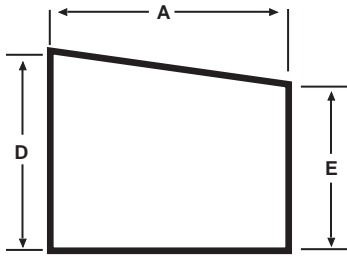

| Size Tube OD D x E | A | Nom. Wall |
|-----------------------|-------|---------------|
| 3/4 x 1/2 | * | 0.065 |
| 1 x 1/2 | * | 0.065 |
| 1 x 3/4 | * | 0.065 |
| 1 1/2 x 1/2 | * | 0.065 |
| 1 1/2 x 3/4 | * | 0.065 |
| 1 1/2 x 1 | 2.000 | 0.065 |
| 1 1/2 x 1 1/4 | 1.000 | 0.065 |
| 2 x 1 | 4.000 | 0.065 |
| 2 x 1 1/4 | 3.000 | 0.065 |
| 2 x 1 1/2 | 2.000 | 0.065 |
| 2 1/2 x 1 1/2 | 4.000 | 0.065 |
| 2 1/2 x 2 | 2.000 | 0.065 |
| 3 x 1 1/2 | 6.000 | 0.065 |
| 3 x 2 | 4.000 | 0.065 |
| 3 x 2 1/2 | 2.000 | 0.065 |
| 4 x 2 | 8.000 | 0.083 x 0.065 |
| 4 x 2 1/2 | 6.000 | 0.083 x 0.065 |
| 4 x 3 | 4.000 | 0.083 x 0.065 |
| 6 x 3 | 5.500 | 0.109 x 0.083 |
| 6 x 4 | 5.500 | 0.109 x 0.083 |

* Contact VNE for Exact Dimensions.

E38SL - SLIP ON FLANGE

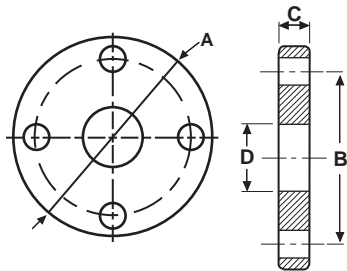

| Size Tube OD | A | B | C | D |
|--------------|-------|-------|-------|-------|
| 1 | 4.250 | 3.125 | 0.375 | 1.010 |
| 1 1/2 | 5.000 | 3.875 | 0.437 | 1.510 |
| 2 | 6.000 | 4.750 | 0.500 | 2.010 |
| 2 1/2 | 7.000 | 5.500 | 0.562 | 2.510 |
| 3 | 7.500 | 6.000 | 0.625 | 3.010 |
| 3 1/2 | 8.500 | 7.000 | 0.625 | 3.510 |
| 4 | 9.000 | 7.500 | 0.689 | 4.010 |

150 PSI Rating

V14RH - 6L B/W Rubber Hose Barb Blank #1

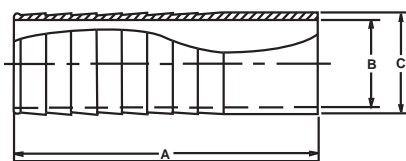

| Size Tube OD | A | B | C |
|--------------|-------|-------|-------|
| 1/4 | 1.500 | 0.120 | 0.250 |
| 5/16 | 1.500 | 0.182 | 0.312 |
| 3/8 | 1.500 | 0.250 | 0.375 |
| 1/2 | 1.500 | 0.375 | 0.500 |
| 5/8 | 1.500 | 0.495 | 0.625 |
| 3/4 | 1.500 | 0.620 | 0.750 |
| 1 | 3.000 | 0.870 | 1.000 |
| 1 1/4 | 3.000 | 1.120 | 1.250 |
| 1 1/2 | 3.000 | 1.370 | 1.500 |
| 2 | 3.000 | 1.870 | 2.000 |
| 2 1/2 | 3.000 | 2.370 | 2.500 |
| 3 | 3.000 | 2.870 | 3.000 |

FITTINGS



Miscellaneous



European Din Connections....

VNE's European Din Connections are available in Inch-Size Tube O.D. Weld Neck. Now inch size tubing can be utilized on projects requiring Din Connections, where in the past metric tubing had to be purchased.

VNE stocks welding ferrules - both male (threaded) and female (plain) - along with the standard DIN nut and gasket to complete the union in T304. T316 ferrules are available upon request.

EUROPEAN DIN SPECIFICATIONS....

Product: Din Connection x Din Weld Connection
Fully Metric Din Fittings

Size Range: Din 10 - Din 100

Materials: T304 & T316

Finish: #7 ID / OD Polish

ORDERING SPECIFICATIONS....

25-KURZ-NW10
(Din male threaded ferrule size 10, T304)

35-KURZ-6-NW10
(Din female plain ferrule size 10, T316)

EUROPEAN DIN SPECIFICATIONS....

Product: Din Connection X Inch Weld
Connection

Size Range: 1" - 4"

Materials: T304 & T316

Finish: #7 ID / OD Polish

ORDERING SPECIFICATIONS....

2SRW-25 X 1.0
(Din male threaded ferrule x size 1" weld connection, T304)

3SRW-6-25X1.0
(Din female plain ferrule x size 1" weld connection, T316)

VNE CORPORATION

P.O. Box 1698 • 1149 Barberry Drive • Janesville, WI 53547

TEL: 608-756-4930 • FAX: 608-756-3643 • 1-800-356-1111 • Web site: vnestainless.com

4-NUT-NW-(SIZE) (304 ONLY)

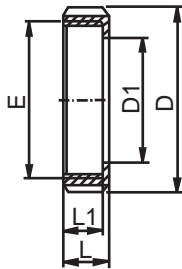

| Size (DN) | D | D1 | E | L | L1 |
|-----------|-----|------|----------------|----|----|
| 10 | 38 | 19 | Rd 28 x 1/8" | 18 | 15 |
| 15 | 44 | 25 | Rd 34 x 1/8" | 18 | 15 |
| 20 | 54 | 31 | Rd x 44 x 1/6" | 20 | 17 |
| 25 | 63 | 36 | Rd 52 x 1/6" | 21 | 18 |
| 32 | 70 | 42 | Rd 58 x 1/6" | 21 | 18 |
| 40 | 78 | 49 | Rd 65 x 1/6" | 21 | 18 |
| 50 | 92 | 62 | Rd 78 x 1/6" | 22 | 19 |
| 65 | 112 | 80 | Rd 95 x 1/6" | 25 | 21 |
| 75/3 | 120 | 86.5 | Rd 104 x 1/6" | 29 | 25 |
| 80 | 127 | 94 | Rd 110 x 1/4" | 29 | 25 |
| 100 | 148 | 115 | Rd 130 x 1/4" | 31 | 26 |
| 125 | 178 | 138 | Rd 160 x 1/4" | 35 | 30 |
| 150 | 210 | 164 | Rd 190 x 1/4" | 40 | 34 |
| 200 | 260 | 215 | Rd 240 x 1/4" | 44 | 38 |

5-RING NW (SIZE) BUNA, 5A-RING NW (SIZE) EPDM, 5B-RING NW (SIZE) SILICONE

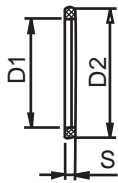

| Size (DN) | D1 | D2 | S |
|-----------|-----|-----|-----|
| 10 | 12 | 20 | 4.5 |
| 15 | 18 | 26 | 4.5 |
| 20 | 23 | 33 | 4.5 |
| 25 | 30 | 40 | 5 |
| 32 | 36 | 46 | 5 |
| 40 | 42 | 52 | 5 |
| 50 | 54 | 64 | 5 |
| 65 | 71 | 81 | 5 |
| 75/3 | 78 | 88 | 5 |
| 80 | 85 | 95 | 5 |
| 100 | 104 | 114 | 6 |
| 125 | 130 | 142 | 7 |
| 150 | 155 | 167 | 7 |

2S-KURZ-NW(SIZE) DIN MALE THREAD X DIN WELD FERRULE T304 / T316

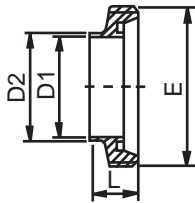

| Size (DN) | D1 | D2 | E | L |
|-----------|-----|-----|---------------|------|
| 10 | 10 | 13 | Rd 28 x 1/8" | 17 |
| 15 | 16 | 19 | Rd 34 x 1/8" | 17 |
| 20 | 20 | 23 | Rd 44 x 1/6" | 19 |
| 25 | 26 | 29 | Rd 52 x 1/6" | 22 |
| 32 | 32 | 35 | Rd 58 x 1/6" | 22 |
| 40 | 38 | 41 | Rd 65 x 1/6" | 22 |
| 50 | 50 | 53 | Rd 78 x 1/6" | 23 |
| 65 | 66 | 70 | Rd 95 x 1/6" | 25 |
| 80 | 81 | 85 | Rd 110 x 1/4" | 25 |
| 100 | 100 | 104 | Rd 130 x 1/4" | 30 |
| 125 | 125 | 129 | Rd 160 x 1/4" | 35.5 |
| 150 | 150 | 154 | Rd 190 x 1/4" | 40 |

3S-KURZ-NW(SIZE) DIN FEMALE X DIN WELD FERRULE T304 / T316

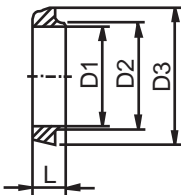

| Size (DN) | D1 | D2 | D3 | L |
|-----------|-----|-----|------|------|
| 10 | 10 | 13 | 22.5 | 13 |
| 15 | 16 | 19 | 28.5 | 13 |
| 20 | 20 | 23 | 36.5 | 13 |
| 25 | 26 | 29 | 44 | 15 |
| 32 | 32 | 35 | 50 | 15 |
| 40 | 38 | 41 | 56 | 15 |
| 50 | 50 | 53 | 68.5 | 16 |
| 65 | 66 | 70 | 86 | 17 |
| 80 | 81 | 85 | 100 | 17 |
| 100 | 100 | 104 | 121 | 20 |
| 125 | 125 | 129 | 150 | 23.5 |
| 150 | 150 | 154 | 176 | 27 |

74-CAP NW(SIZE) (304 & 316)

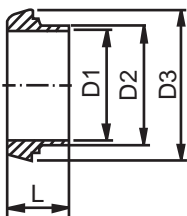

| Size (DN) | D1 | D2 | D3 | L |
|-----------|-------|------|------|-----|
| 10 | 18.8 | 22.5 | 9.5 | 3.5 |
| 15 | 24.8 | 28.5 | 9.5 | 3.5 |
| 20 | 30.8 | 36.5 | 11.5 | 3.5 |
| 25 | 35.8 | 44 | 13.5 | 3.5 |
| 32 | 41.8 | 50 | 13.5 | 3.5 |
| 40 | 48.8 | 56 | 13.5 | 3.5 |
| 50 | 61.8 | 68.5 | 14.5 | 3.5 |
| 65 | 79.8 | 86 | 16.5 | 4.5 |
| 80 | 93.8 | 100 | 16.5 | 4.5 |
| 100 | 114.8 | 121 | 20.5 | 5.5 |
| 125 | 137.8 | 150 | 22.5 | 5.5 |
| 150 | 163.8 | 176 | 24.5 | 6.5 |

2SRW (SIZE) DIN MALE THREAD X INCH WELD FERRULES T304 / T316

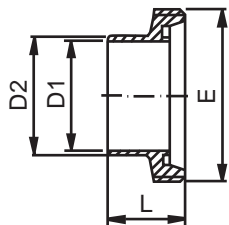

| Size (DN) | D1 | D2 | E | L |
|-----------|------|-------|---------------|----|
| 25 x 1.0 | 22.9 | 1.000 | Rd 52 x 1/6" | 29 |
| 40 x 1.5 | 35.1 | 1.500 | Rd 65 x 1/6" | 33 |
| 50 x 2.0 | 47.8 | 2.000 | Rd 78 x 1/6" | 35 |
| 65 x 2.5 | 60.5 | 2.500 | Rd 95 x 1/6" | 40 |
| 80 x 3.0 | 72.2 | 3.000 | Rd 104 x 1/6" | 40 |
| 100 x 4.0 | 97.6 | 4.000 | Rd 130 x 1/4" | 54 |

3SRW (SIZE) DIN FEMALE X INCH WELD FERRULES T304 / T316

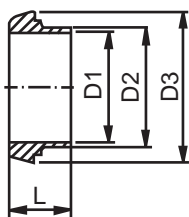

| Size (DN) | D1 | D2 | D3 | L |
|-----------|------|-------|------|----|
| 25 x 1.0 | 22.9 | 1.000 | 44 | 22 |
| 40 x 1.5 | 35.1 | 1.500 | 56 | 26 |
| 50 x 2.0 | 47.8 | 2.000 | 68.5 | 28 |
| 65 x 2.5 | 60.5 | 2.500 | 86 | 32 |
| 80 x 3.0 | 72.2 | 3.000 | 93 | 32 |
| 100 x 4.0 | 97.6 | 4.000 | 121 | 44 |



Pipe Hangers....

Pipe Hangers are available in Tube OD sizes. All hangers are hexagonal shape with either rubber grommets or PVC inserts. Hangers are also available with a 3/8" coupling.

Larger tube OD and pipe sizes are available upon special request.

PIPE HANGER SPECIFICATIONS....

Product: Tube OD Piping Hangers

Size Range: 1/2" through 6" sizes

Materials: T304 - Hangers
Rubber / Viton - Grommets
PVC - Sleeve insert

ORDERING SPECIFICATIONS....

Specify:

- Quantity
- Product description or Part No.
- Size
- Material Type

VNE CORPORATION

P.O. Box 1698 • 1149 Barberry Drive • Janesville, WI 53547

TEL: 608-756-4930 • FAX: 608-756-3643 • 1-800-356-1111 • Web site: vnestainless.com

PIPE HANGERS

E24

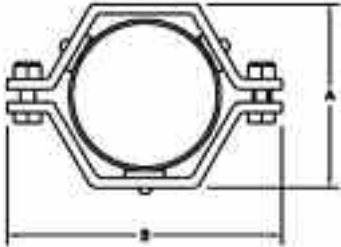

| Size Tube OD | A | B |
|-----------------|-------|--------|
| 1/2 | 2 1/8 | 3 5/8 |
| 3/4 | 2 1/8 | 3 5/8 |
| 1 | 2 1/8 | 3 5/8 |
| 1 1/2 | 2 1/8 | 3 5/8 |
| 2 | 2 5/8 | 4 5/16 |
| 2 1/2 | 3 1/8 | 4 7/8 |
| 3 | 3 5/8 | 5 3/8 |
| 4 | 4 3/4 | 6 9/16 |
| 6 | 6 5/8 | 9 |

E24C

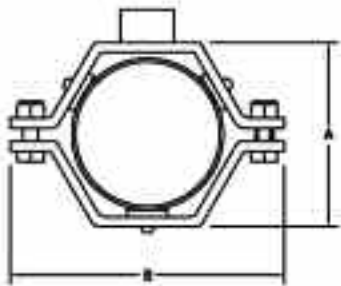

| Size Tube OD | A | B |
|-----------------|-------|--------|
| 1/2 | 2 1/8 | 3 5/8 |
| 3/4 | 2 1/8 | 3 5/8 |
| 1 | 2 1/8 | 3 5/8 |
| 1 1/2 | 2 1/8 | 3 5/8 |
| 2 | 2 5/8 | 4 5/16 |
| 2 1/2 | 3 1/8 | 4 7/8 |
| 3 | 3 5/8 | 5 3/8 |
| 4 | 4 3/4 | 6 9/16 |
| 6 | 6 5/8 | 9 |

E24PVC

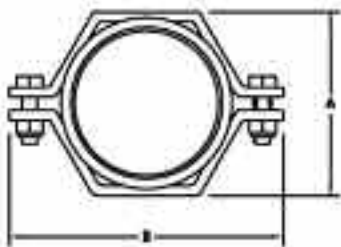

| Size Tube OD | A | B |
|-----------------|-------|---------|
| 1/2 | 2 | 3 5/8 |
| 3/4 | 2 1/8 | 3 5/8 |
| 1 | 2 1/8 | 3 5/8 |
| 1 1/2 | 2 1/8 | 3 5/8 |
| 2 | 2 5/8 | 4 5/16 |
| 2 1/2 | 3 1/8 | 4 13/16 |
| 3 | 3 5/8 | 5 3/8 |
| 4 | 4 3/4 | 6 1/2 |
| 6 | 6 5/8 | 9 |

Stainless Steel Special Fabrications

Modern Manufacturing Facility

To uphold our commitment to have one of the most shortest lead times in the industry, we have expanded our manufacturing facility to keep up with the demands of our customers.



State of the art machinery

With the most precise and state of the art machinery, VNE is committed to manufacture quality speciality products in the most efficient manner possible.



Experienced People

VNE recognizes that even with our modern facility and state of the art machinery, experienced people are the most valuable asset we have to offer. Our craftsmanship provided the key to a quality product with a fast turn-around at a competitive price.

Quality Specialty Products

VNE can manufacturer products to your specific requirements for the Food,Dairy, Beverage, Pharmaceutical and many other industries.





BUTTERFLY VALVES

Butterfly Valves are available in Manual, Air Actuated, or Air Actuated with two Micro switches and a Solenoid Valve. Clamp or Weld ends are standard. Other connections are available upon request.

Available seat materials include Silicone, Viton®, and EPDM. Size range from 1" through 4". All products contact surfaces are available in either T304 or T316 stainless steel.



CHECK VALVES

Check valves are widely used for both sanitary and industrial applications to prevent backflow of product.

VNE's ball check valves are designed to allow full product flow during processing. Once the product flow stops the ball rolls back to seat at inlet, preventing back flow. Ball Check Valves are commonly used with liquid products.

VNE's spring check valves are designed to assist closure pressure to create a positive shutoff. They are commonly used with liquid products.

Both valves are offered with clamp and weld ends. Other connections are available upon request. Sizes range from 1/2" through 4" in T316 stainless steel. VNE's Check Valves meet 3A Sanitary requirements.

VNE's Air Blow Check Valves are designed to evacuate lines of product or CIP solution. Air Blow Check Valves are made of T316L Stainless Steel and are offered with EPDM or Viton® Elastomers.



BALL VALVES

Ball Valves are used in a wide variety of high pressure applications. Two factors make them popular. First, a full unrestricted flow that allows no product restrictions through the valve. Second, the three piece design and the removal of a minimal number of bolts allows service to be performed without the removal of the complete valve from the line.

VNE offers TWO and THREE way ball valves made of T316 (CF8M) stainless steel. Ball Valves are available in Manual, Pneumatically Actuated, and Electrically Actuated versions. We also offer a full line of control options. Limit switches, Solenoids, and Positioners can be included with your automated valve assembly. VNE Ball Valves feature PTFE seats that are easily removed. Clamp and Weld ends are standard. Other connections are available upon request. 1/2" -4" sizes are available. VNE Ball Valves meet FDA and 3A requirements.



PVA VALVES

PVA Valves are available in Manual, Air Activated, or Air Actuated with an electronic control head.

Configurations can be shut off, Divert or Tank outlet. Connections consist of Clamp, Weld, Bevel Seat, and E-Line.

VNE's PVA Valves are made of T316L stainless steel which meet all 3A requirements and are offered in 1/2" through 3" sizes. Other connections available upon request.



MaxPure® BPE Fittings..... Maximum Purity with Guaranteed Ra

VNE's Bio-Pharm Fittings are manufactured in accordance to ASME BPE specifications. In addition to heat numbers being permanently etched, a manufacturing job number is also etched. This ensures total traceability for a consistent, high quality product manufactured specifically for the pharmaceutical and high purity markets.

VNE AFFILIATIONS...

VNE is an active member of numerous industry-related organizations and associations.

3-A®

VNE is a member of 3-A®, a voluntary organization committed to safeguarding public health and dairy product quality through a unique industry-regulated program of sanitary standards for equipment used in processing dairy foods.

WCMA

Wisconsin Cheese Makers Association

VNE is a member of WCMA, a nonprofit trade association dedicated to improving the business climate for dairy companies, primarily cheese and butter manufacturing and marketing companies. Their actions also extend to the companies that supply goods and services to the dairy industry.

FISA

Food Industry Suppliers Association

VNE is a member of FISA, a national association of independent distributors and major manufacturers of sanitary supplies used in the food, dairy, beverage, pharmaceutical and personal care industries.

FPSA

Food Processing Suppliers Association

VNE is a member of FPSA, an association serving suppliers to the global food, beverage, and pharmaceutical industries.

ISPE

The International Society for Pharmaceutical Engineering

VNE is a member of ISPE, a not-for-profit volunteer Society of technical professionals, who apply their practical knowledge in the regulated healthcare manufacturing industries. ISPE is committed to advancement of the education and technical efficiency of its members through forums for the exchange of ideas and practical experience.

ASME

American Society of Mechanical Engineers

VNE is a member of ASME International, a nonprofit educational and technical organization serving worldwide membership of 125,000. Established to promote technical competency through quality programs and activities in the mechanical engineering fields.